

# TaesLab: Tool for Thermoeconomic Analysis of Industrial Energy Systems

- TaesLab is a Matlab-based software package for the thermoeconomic analysis of industrial energy systems.
- It is based on the thermoeconomic analysis work developed since 1986 in the University of Zaragoza.
- The Package is provided as:
  - An interactive set of functions
  - A Matlab app
  - A standalone application
- Its main features are:
  - Import thermodynamic data from external applications.
  - Data model could be defined in Excel files and other structured data file formats
  - Calculation of direct and generalised exergy costs.
  - Analysis of product and waste cost allocation
  - Thermoeconomic diagnosis
  - Recycling Analysis
  - Export of results for further analysis

# TaesLab Installation

- The TaesLab package is available in the [Exergoecology Portal](#). Download the TaesLab.zip file and unzip it in the folder where you want to install it.
- Open the Matlab application. In the HOME menu, select the Set Path option in the ENVIRONMENT block, to register the TaesLab software.

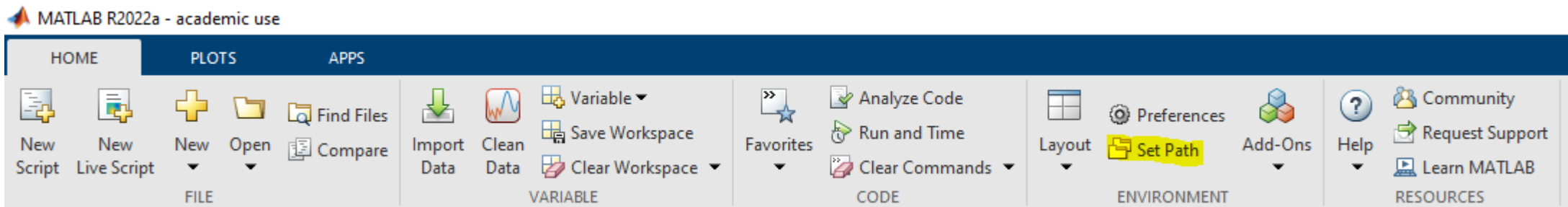

# TaesLab Installation

- Use the **Add Folder...** or **Add with Subfolders...** button to add the TaesLab folder and its subfolders (except Examples). Once these folders have been added to the **MATLAB search path**, click the **Save button** and close the dialog box.

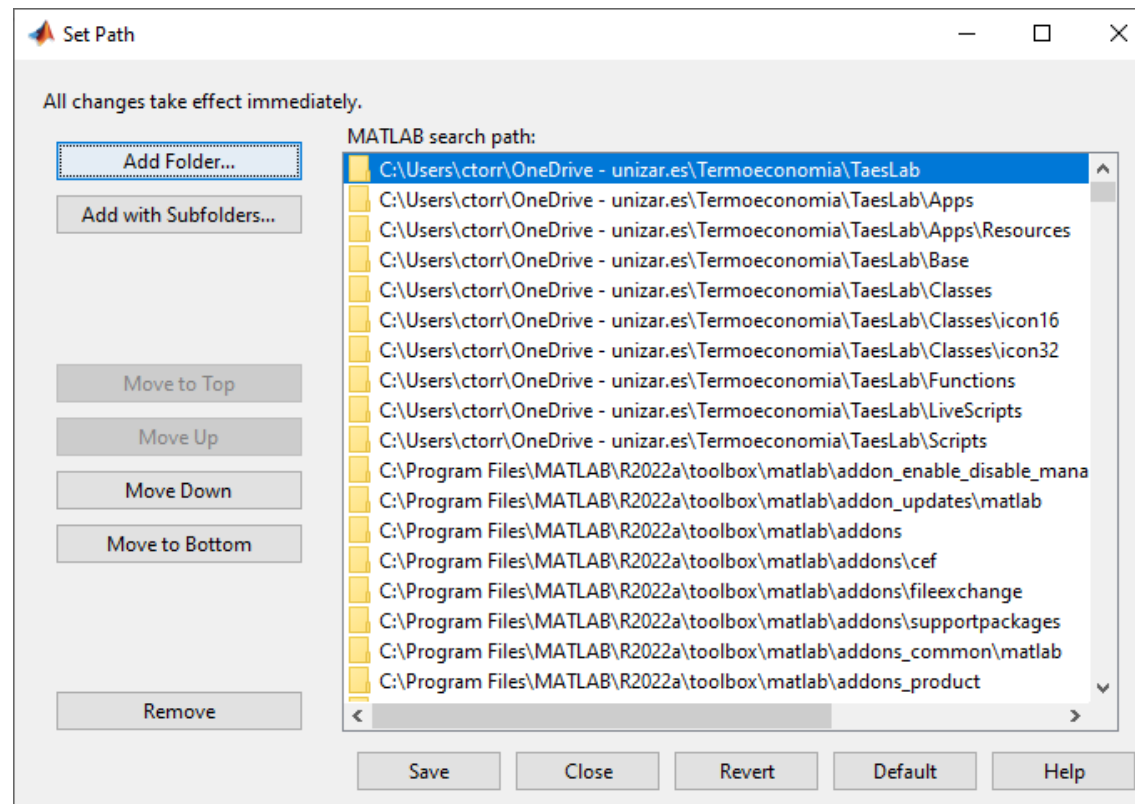

# Install TaesLab App

- To install the TaesLab toolbox, double-click on the file TaesLab.mlappinstall, inside the Current Folder panel, then the APPS tab and an install window will appear.

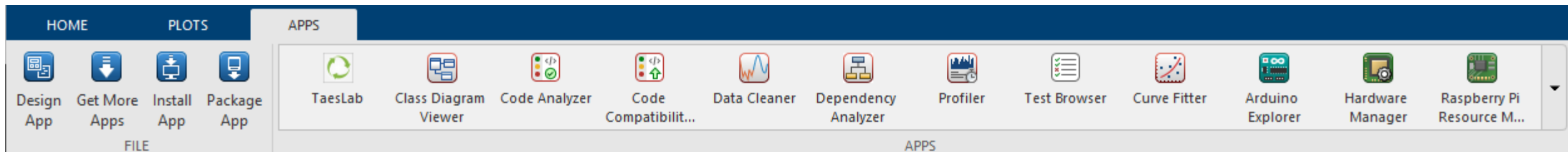
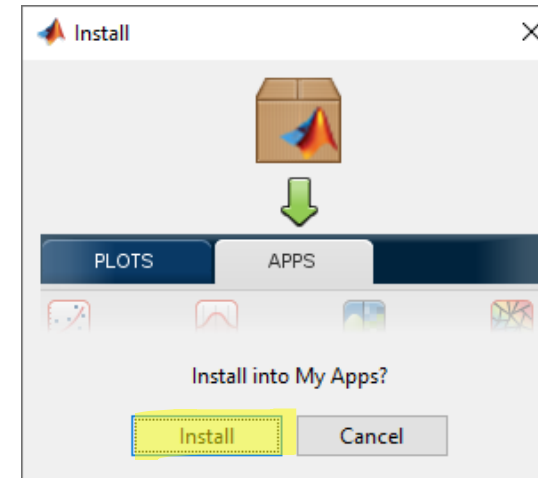
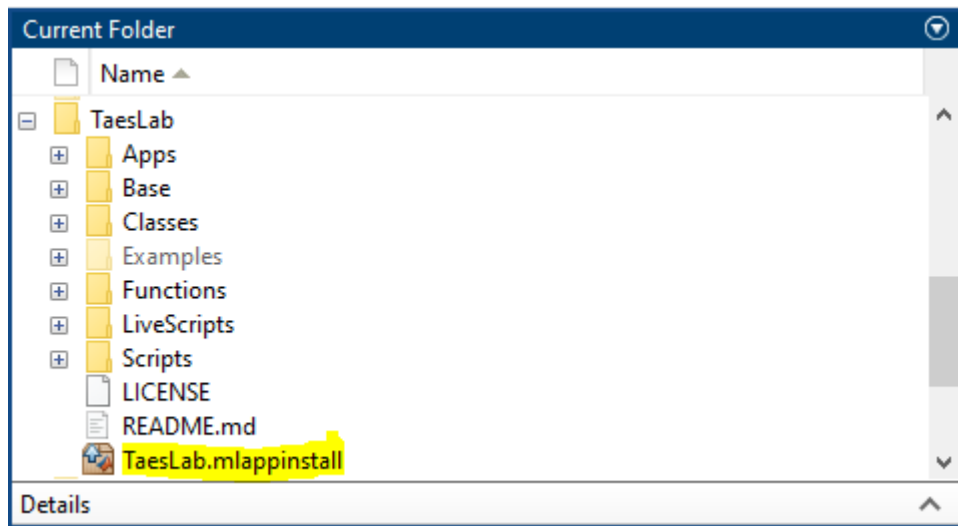

# TaesLab Description

- TaesLab package implements the latest developments and updates of the Exergy Cost Theory, with emphasis on the issues of waste cost allocation and recycling analysis, hence the name Circular Thermoconomics.
- The TaesLab software is structured in four layers of work:
  - Reader layer: Reads the thermo-economic model of the plant from external files.
  - Data Model Layer: Builds the internal data model, which provides the information required by the thermo-economic analysis modules.
  - Computation Layer: Performs the calculations required by the thermo-economic analysis.
  - Results Info Layer: Receives the results of the thermo-economic analysis, and displays them in the form of tables, graphs, exports to external files or to the MATLAB environment.

# TaesLab Layer Structure

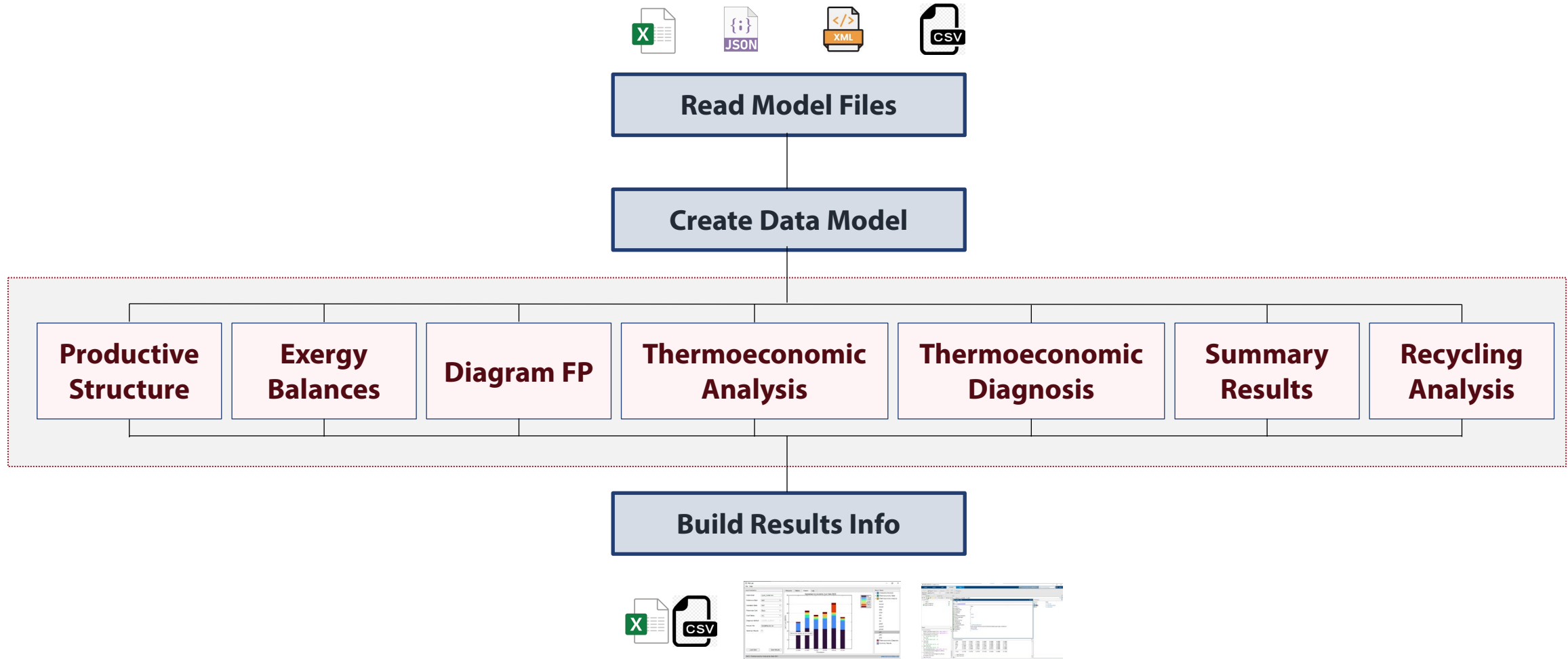

TAES Lab
— □ ×

File Help

*Input Parameters*

Data Model: Not Model Available

Reference State:

Operation State:

Resources Cost:

Cost Tables:

Diagnosis Method:

Results File:

Summary Results:

Load Data
Save Results

Welcome | Tables | Graphs | Log

## Thermoeconomic Analysis of Energy System

# TAES Lab

*Result Tables*

- PS Productive Structure
- TS Thermoeconomic State
- TA Thermoeconomic Analysis
- TD Thermoeconomic Diagnosis
- SR Summary Results

**CIRCE**  
Universidad Zaragoza

**Universidad**  
Zaragoza

[www.exergoecology.com](http://www.exergoecology.com)



- The TAESLab application has three work panels:
  - Input Parameters (Left Panel)
  - Result Tables Selection (Right Panel)
  - Show Results Area (Central Panel)
- In the left panel, the model data to be analysed are selected and some of the application parameters are configured.
- In the central panel, the results are displayed: Tables, Graphs and lists of messages.
- In the right panel you select the tables of results you want to show, grouped by functions: Productive Structure, Thermo-economic Status, Thermo-economic Analysis, Thermo-economic Diagnosis and Summary Results

# Input Parameters Panel

- Data Model: Indicates the file used as the data model. It is selected by pressing the **Load Data** button
- Reference State: Reference State used for diagnosis.
- Operation State: Name of the state (Exergy Values) used for thermoeconomic analysis and diagnosis.
- Resources Cost: Name of the resource data used to calculate generalised costs (if applicable).
- Cost Tables: Select the type of tables to be displayed.
- Diagnosis Method: Method to be used for diagnosis
- Result File: Indicates the file name where the results will be saved. It is selected by clicking on the **Save Results** button
- Summary Results: Activates the cost summary tables.

The screenshot shows a software interface titled "Input Parameters". It contains several input fields and buttons:

- Data Model:** A red box containing the text "Not Model Available".
- Reference State:** A dropdown menu with "Reference" selected.
- Operation State:** A dropdown menu with "Reference" selected.
- Resources Cost:** A dropdown menu with "Base" selected.
- Cost Tables:** A dropdown menu with "DIRECT" selected.
- Diagnosis Method:** A dropdown menu with "WASTE\_OUTPUT" selected.
- Results File:** A text input field containing "ModelResults.xlsx".
- Summary Results:** An unchecked checkbox.
- Buttons:** "Load Data" and "Save Results" buttons are located at the bottom of the panel.

- The information necessary to perform a thermoeconomic analysis of a plant must be prepared in a \*.xlsx file. Other format (\*.csv, \*.json, \*.xml) are also allowed.
- A template file *plant\_model.xlsx* is provided in folder Examples
- This file has several sheets where the information is written:
  - Flows: Plant Flows
  - Processes: Plant processes
  - Exergy: Exergy of the flows for different states of the plant.
  - Format: Numerical units and formats are indicated for each type of variable.
  - ResourcesCost (optional): External resource costs
  - WasteDefinition (optional): Cost allocation criteria for each waste
  - Waste Allocation (optional): Manual allocation for the internalisation of waste costs
- Additional sheets with other information can be added

# Data Model. Physical Diagram

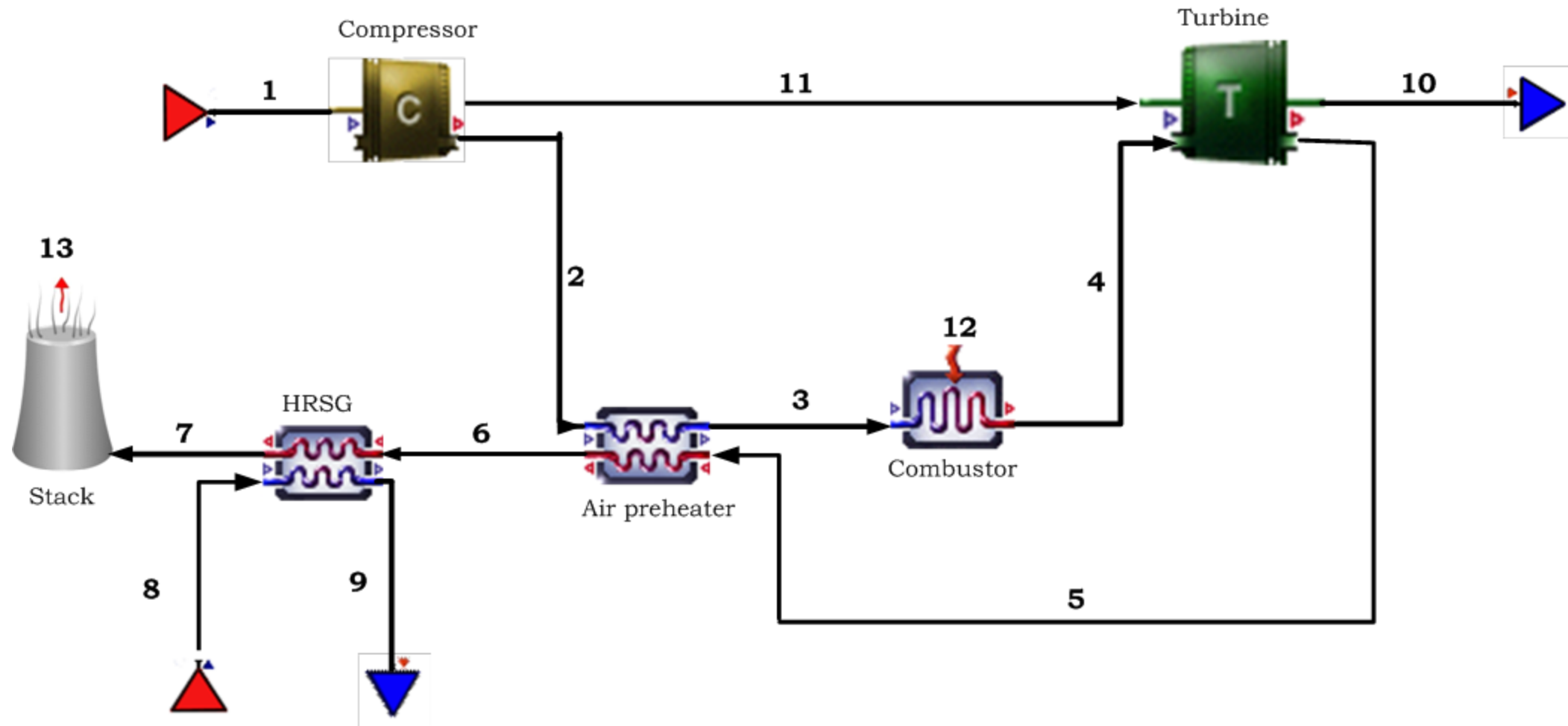

# Data Model. Flows

- The Flows table defines the system flows.
- Each flow in the system has a key that identifies it.
- Each flow has a type that indicates its relationship with the environment.
  - INTERNAL: Connects two system processes
  - RESOURCE: It is an input to the system
  - OUTPUT: It is an end product of the system.
  - WASTE: It is a residue of the system.

key	type
B1	RESOURCE
B2	INTERNAL
B3	INTERNAL
B4	INTERNAL
B5	INTERNAL
B6	INTERNAL
B7	INTERNAL
B8	RESOURCE
B9	INTERNAL
WN	OUTPUT
WC	INTERNAL
NG	RESOURCE
QG	WASTE

# Data Model. Process

- The Processes table defines the processes of the system.
- Each process has an identifier (key) and optionally a description can be included.
- The fuel and the product of each equipment is defined, using the identifiers of the flows defined in the previous table.
- Processes can be of two types:
  - PRODUCTIVE: Processes whose products are internal flows (INTERNAL) or final products (OUTPUT).
  - DISIPATIVE: Processes whose product is a waste (WASTE).

key	fuel	product	type	description
COMB	NG	B4-B3	PRODUCTIVE	Combustor
COMP	WC	B2-B1	PRODUCTIVE	Compressor
TURB	B4-B5	WC+WN	PRODUCTIVE	Turbine
HEAT	B5-B6	B3-B2	PRODUCTIVE	Prehater
HRSG	B6-B7	B9-B8	PRODUCTIVE	HRSG
STCK	B7	QG	DISSIPATIVE	Stack

# Fuel-Product definition

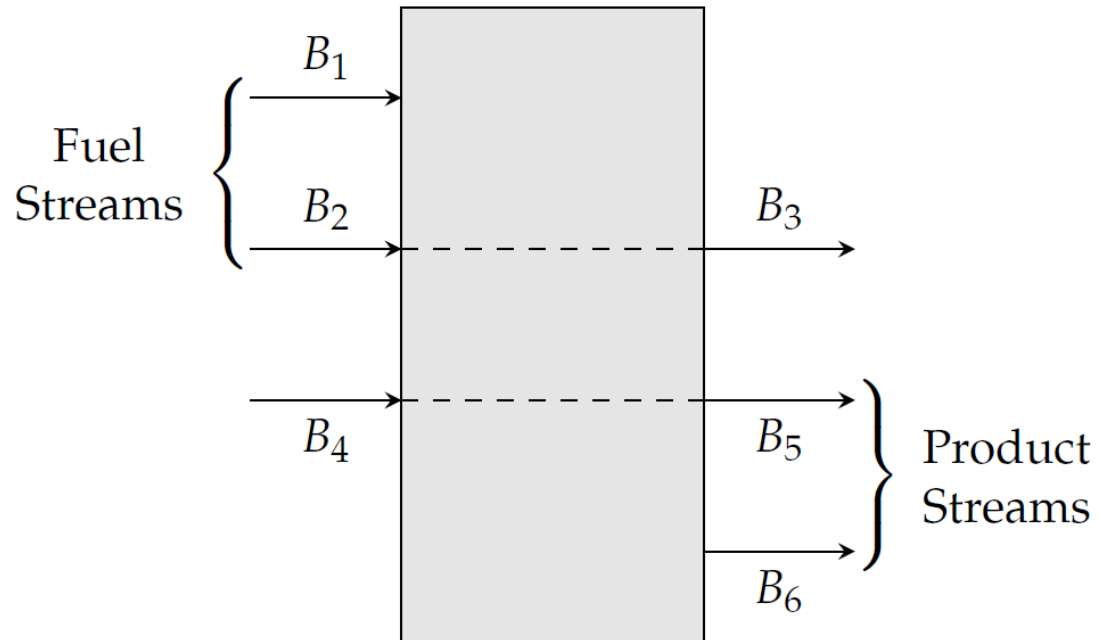

**Fuel:**  $B_1 + (B_2 - B_3)$

**Product:**  $(B_5 - B_4) + B_6$

- If a process has more than one productive group of fuel or product, and at least one of them has inputs and outputs, these have to be put in brackets.
- In this case cost equations will be:

$$k_3^* = k_2^* \qquad k_6^* = \frac{B_5^* - B_4^*}{B_5 - B_4}$$

- Without brackets the cost equations will be different

$$k_3^* = \frac{B_1^* + B_2^*}{B_1 + B_2} \qquad k_6^* = k_5^*$$

# Data Model. Exergy

- The **Exergy** table stores the values of the flow exergies for different plant states.
- The key must have the same identifier as in the **Flows** table.
- The column names identify the State name used in the fields of the **input parameters** panel.
- The units in which their values are presented are defined in the **Format** table.

key	REF	T1180	ETG87	ECMP84	RP84
B1	0	0	0	0	0
B2	28.511	29.338	29.096	29.063	28.311
B3	47.246	47.84	48.499	47.89	47.364
B4	104.268	105.253	106.398	105.588	104.389
B5	40.496	40.502	41.747	41.009	40.84
B6	19.557	19.815	20.064	19.986	19.532
B7	2.092	2.207	2.116	2.087	2.11
B8	0	0	0	0	0
B9	12.626	12.745	12.97	12.931	12.599
WN	30	30	30	30	30
WC	31.096	31.998	31.734	31.87	30.891
NG	82.711	83.674	83.964	83.688	82.711
QG	2.092	2.207	2.116	2.087	2.11



# Data Model. Format

- The **Format** table defines the formats to be used to present the tables of results, for each of the different types of variables
  - **width:** The total number of characters with which the number will be represented.
  - **precision:** Number of decimals with which the results are represented.
  - **unit:** Text of the unit of the magnitude to which it corresponds.

key	width	precision	unit
EXERGY	11	3	(MW)
EXERGY_COST	11	3	(MW)
EXERGY_UNIT_COST	11	4	(J/J)
GENERALIZED_COST	11	3	(\$/h)
GENERALIZED_UNIT_COST	11	3	(\$/MWh)
DIAGNOSIS	11	4	(MW)

# Data Model. ResourcesCost

- The **ResourcesCost** table contains the values of the external resource costs.
- It is optional. If defined, generalised exergy costs are calculated.
- Both flow and process related costs are included. It is marked in the **type** column.
- We can put several sets of values identified by the column's name. This name is used in the **Resources Cost** field of the Input Parameters panel.
- The units shall be those indicated in the **Format** table and must be consistent.

key	type	Base
NG	FLOW	20
COMB	PROCESS	3.6
COMP	PROCESS	32.5
TURB	PROCESS	46
HEAT	PROCESS	20
HRSG	PROCESS	29

In this example the values are (\$/MWh) for the unit cost of natural gas (NG) and (\$/h) for the amortisation cost of the processes.

# Modelo de datos. Internalización de Residuos

- The **WasteDefinition** table defines for each waste (**key**) the internalisation method to be used (**type**). The methods are explained in the next slide. It can also be indicated (optionally) if a part of the waste is recycled.
- This table is optional, if not indicated, the DEFAULT method will be used.
- If the MANUAL method is chosen, the **WasteAllocation** table must be defined, where the part of the waste to be allocated for each production process is indicated.

**WasteDefinition**

key	type	recycling
QG	MANUAL	0.0

**WasteAllocation**

key	QG
COMB	0.76
COMP	0.08
TURB	0.08
HEAT	0.08

# Waste cost internalisation methods

- **RESOURCES:** This method distributes the cost of waste proportionally to the external resources consumed to generate it (It is the DEFAULT method).
- **EXERGY:** The cost of the waste is allocated to the processes that produced it and distributed proportionally to the exergy of the flows processed in the dissipating units.
- **COST:** The cost of the residue is assigned to the processes that produced it and distributed proportionally to the exergy cost of the flows processed in the dissipative units.
- **IRREVERSIBILITY:** The cost of the residue is assigned to the processes that produced it and distributed proportionally to the irreversibility generated when producing them.
- **HYBRID:** A combination of the EXERGY and IRREVERSIBILITY methods.
- **MANUAL:** Values are defined manually.

## Application Basic Guide (Left Panel)

- Click the **Load Data** button to load the data model. A dialog window will appear to select the file. Once the data model has been loaded, a table appears in the central panel with information about possible errors and tables validation (**Log tab**)
- If the data model is valid, the right panel activates the branches of the tree associated with the Production Structure, Thermo-economic State and Thermo-economic Analysis corresponding to the Operation State and Resource Costs sample.
- The drop-down menus of the left panel are activated to select other Operation States or Resource Costs samples, as well as to select the type of tables to be displayed (Cost Tables), select the Diagnosis Method or activate the Summary Results

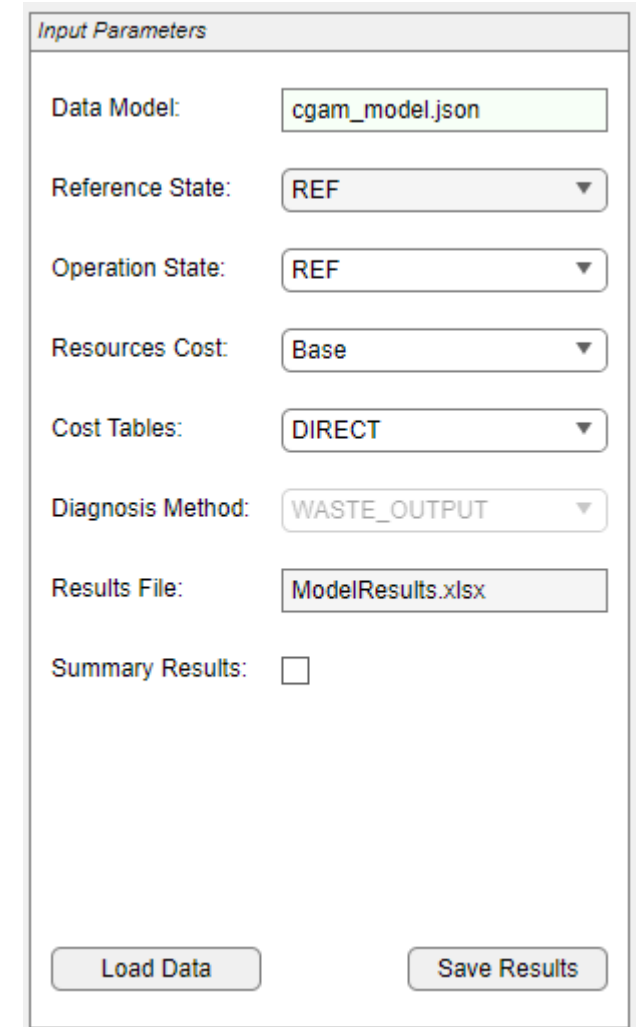

*Input Parameters*

Data Model:

Reference State:

Operation State:

Resources Cost:

Cost Tables:

Diagnosis Method:

Results File:

Summary Results:

# Application Basic Guide (Results Blocks)

- There are five block of results, which can be selected in the right panel
  - PS **Productive Structure:** Show the definition and connectivity of **flows, processes** and **productive groups** of the plant.
  - TS **Thermoeconomic State:** Show the **exergy** values of flows and productive groups, show **the exergy balance** of the **plant processes** and the Fuel-Product table, for the current state of the plant.
  - TA **Thermoeconomic Analysis:** Show the cost tables of flows and processes
  - TD **Thermoeconomic Diagnosis:** Show the diagnosis tables comparing the Reference State and the Operation (Current) state.
  - SR **Summary Results:** Show the summary cost tables comparing the defined states of the plant.

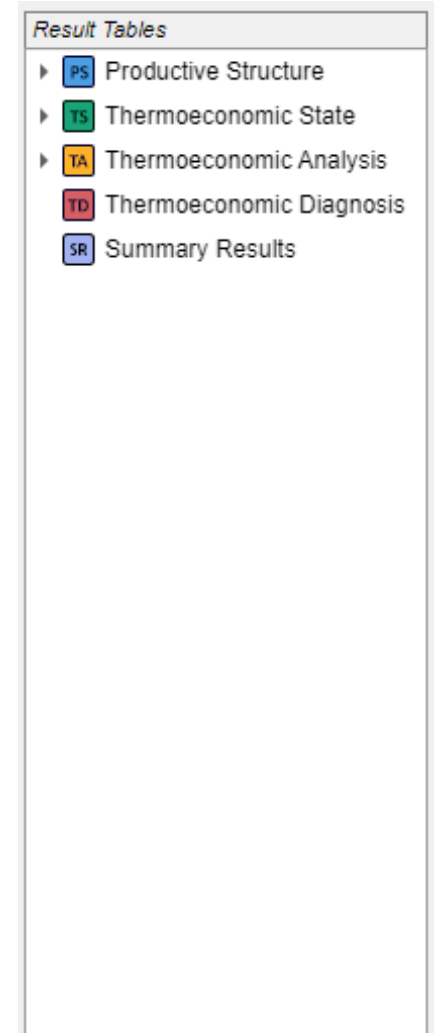

## Application Basic Guide (Right Panel)

- When select or expand one of the nodes, an index table with the description of all tables, available in the node, appears on the **Tables Tab** on the central panel.
- Select the branch of the results block you want to see, then the list of available tables appears. Select the desired table, and the values appear in the **Tables Tab** of the central panel.
- If the selected table has a graphical representation, it can be viewed by clicking on the **Graphs Tab** in the central panel.

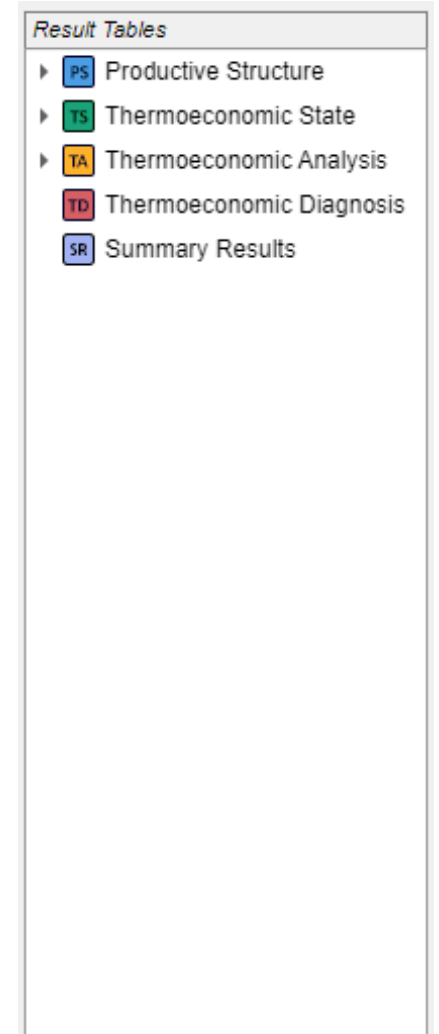

# Results Tables (Message Log Tab)

The screenshot shows the TAES Lab software interface. The window title is "TAES Lab" and it has a menu bar with "File" and "Help".

**Input Parameters:**

- Data Model:
- Reference State:
- Operation State:
- Resources Cost:
- Cost Tables:
- Diagnosis Method:
- Results File:
- Summary Results:

**Log Table:**

Type	Class	Text
INFO	cStatusLogger	Productive Structure is valid
INFO	cStatusLogger	Format Configuration is valid
INFO	cStatusLogger	Exergy values [REF] are valid
INFO	cStatusLogger	Exergy values [T1180] are valid
INFO	cStatusLogger	Exergy value [T1180] are valid
INFO	cStatusLogger	Exergy values [ECMP84] are valid
INFO	cStatusLogger	Exergy values [RP84] are valid
INFO	cStatusLogger	Exergy values [PINCH10] are valid
INFO	cStatusLogger	Resources Cost sample [Base] is valid
INFO	cStatusLogger	Waste definition is valid
INFO	cReadModelJSON	Data Model cgam_model.json is valid

**Result Tables:**

- PS Productive Structure
- TS Thermoeconomic State
- TA Thermoeconomic Analysis
- TD Thermoeconomic Diagnosis
- SR Summary Results

**Buttons:** Load Data, Save Results

**Status Bar:** INFO: Thermoeconomic State for State REF. [www.exergoecology.com](http://www.exergoecology.com)



# Results Tables (Tables Tab)

The screenshot displays the TAES Lab software interface. The main window is titled 'TAES Lab' and has a menu bar with 'File' and 'Help'. The interface is divided into several sections:

- Input Parameters:** A panel on the left containing several input fields and dropdown menus:
  - Data Model:
  - Reference State:
  - Operation State:
  - Resources Cost:
  - Cost Tables:
  - Diagnosis Method:
  - Results File:
  - Summary Results:
- Navigation:** A set of tabs at the top: 'Welcome', 'Tables' (highlighted), 'Graphs', and 'Log'.
- Process Unit Exergy Cost:** A table with the following data:

	kP*(J/J)	kPe*(J/J)	kPr*(J/J)	kF*(J/J)	kR*(J/J)	k(J/J)
COMB	1.5163	1.4505	0.0658	1.0000	0.0658	1.4505
COMP	1.8688	1.7877	0.0811	1.7134	0.0000	1.0907
TURB	1.7134	1.6391	0.0743	1.6415	0.0000	1.0438
HEAT	1.7927	1.7149	0.0778	1.7354	0.0000	1.0330
HRSG	2.4797	2.3721	0.1076	1.7927	0.0000	1.3833
STCK	1.7927	1.7149	0.0778	1.7927	0.0000	1.0000
- Result Tables:** A sidebar on the right showing a tree view of result tables:
  - PS Productive Structure
  - TS Thermo-economic State
  - TA Thermo-economic Analysis
    - dcost
    - ducost** (highlighted)
    - dfcost
    - dcfp
    - dcfpr
    - dict
    - dfict
    - wa
    - gcost
    - gucost
    - gfcost
    - gict
    - gfict
    - gcfp
  - TD Thermo-economic Diagnosis
  - SR Summary Results

At the bottom of the window, there is an information bar: 'INFO: Thermo-economic Analysis for State REF.' and a website link: [www.exergoecology.com](http://www.exergoecology.com)

# Results Tables (Graphs Tab)

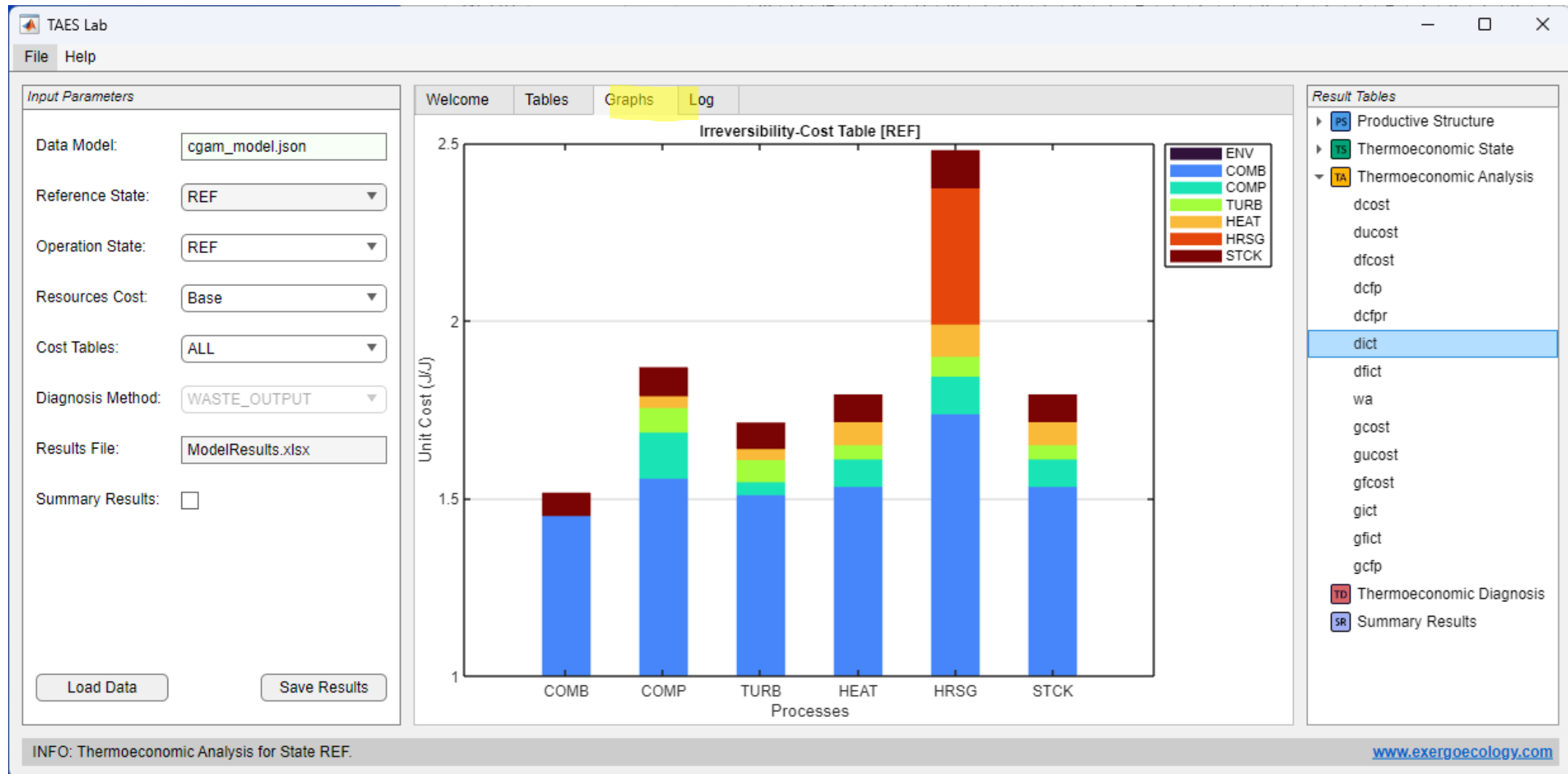

# Productive Structure Results

- PS Shows the definition and connections of flows, processes and productive groups
- PS Appears when the data model is loaded and doesn't change during the all the analysis.
- PS Shows the following tables:
  - **flows:** Information about the flows of the plant, indicating the productive group of origin and destination.
  - **streams:** Information about the productive groups that have been defined.
  - **processes:** Information about the plant's processes

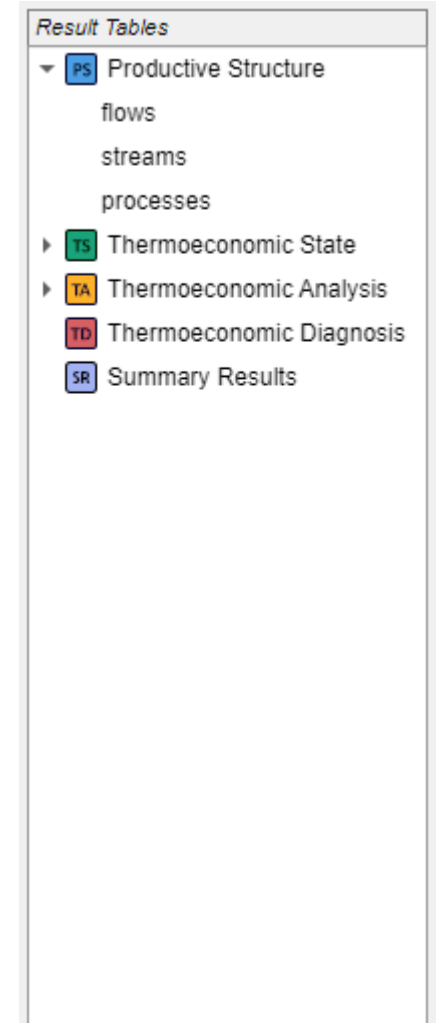

Result Tables	
PS	Productive Structure
	flows
	streams
	processes
TS	Thermoeconomic State
TA	Thermoeconomic Analysis
TD	Thermoeconomic Diagnosis
SR	Summary Results

# Productive Structure Results

The screenshot displays the TAES Lab software interface. The window title is "TAES Lab" and it includes a menu bar with "File" and "Help".

**Input Parameters:**

- Data Model: cgam\_model.xlsx
- Reference State: REF
- Operation State: REF
- Resources Cost: Base
- Cost Tables: DIRECT
- Diagnosis Method: WASTE\_OUTPUT
- Results File: ModelResults.xlsx
- Summary Results:

**Productive Structure Table:**

	Description
flows	Flows Definition Table
streams	Productive Groups Definition Table
processes	Processes Definition Table

A button labeled "Show the results as tables" is located below the table.

**Result Tables:**

- PS Productive Structure
  - flows
  - streams
  - processes
- TS Thermoeconomic State
- TA Thermoeconomic Analysis
- TD Thermoeconomic Diagnosis
- SR Summary Results

**Status Bar:** INFO: Valid Data Model [www.exergoecology.com](http://www.exergoecology.com)

# Productive Structure Results

The screenshot displays the TAES Lab software interface. The window title is 'TAES Lab' and it has a menu bar with 'File' and 'Help'. The interface is divided into several sections:

- Input Parameters:** A panel on the left containing several input fields and dropdown menus:
  - Data Model: cgam\_model.xlsx
  - Reference State: REF
  - Operation State: REF
  - Resources Cost: Base
  - Cost Tables: DIRECT
  - Diagnosis Method: WASTE\_OUTPUT
  - Results File: ModelResults.xlsx
  - Summary Results:
- Flows Definition Table:** A table with columns 'From', 'To', and 'Type'. It lists various flows and their types.
- Result Tables:** A sidebar on the right showing a tree view of results. The 'Productive Structure' (PS) is expanded, showing 'flows', 'streams', and 'processes'. Other results include 'Thermoeconomic State' (TS), 'Thermoeconomic Analysis' (TA), 'Thermoeconomic Diagnosis' (TD), and 'Summary Results' (SR).
- Buttons:** 'Load Data' and 'Save Results' are located at the bottom left. A 'Show the results as tables' button is located in the center-right area.
- Status Bar:** At the bottom, it shows 'INFO: Productive Structure for State REF.' and the website 'www.exergoecology.com'.

Welcome Tables Graphs Log

Flows Definition Table

	From	To	Type
NG	ENV_R1	COMB_F1	RESOURCE
B1	ENV_R2	COMP_P1	RESOURCE
B2	COMP_P1	PHTR_P1	INTERNAL
B3	PHTR_P1	COMB_P1	INTERNAL
B4	COMB_P1	TURB_F1	INTERNAL
B5	TURB_F1	PHTR_F1	INTERNAL
B6	PHTR_F1	HRSG_F1	INTERNAL
B7	HRSG_F1	STCK_F1	INTERNAL
B8	ENV_R3	HRSG_P1	RESOURCE
B9	HRSG_P1	ENV_O1	OUTPUT
WN	TURB_P1	ENV_O2	OUTPUT
WC	TURB_P1	COMP_F1	INTERNAL
QG	STCK_P1	ENV_W1	WASTE

Show the results as tables

INFO: Productive Structure for State REF.

[www.exergoecology.com](http://www.exergoecology.com)

# Productive Diagram

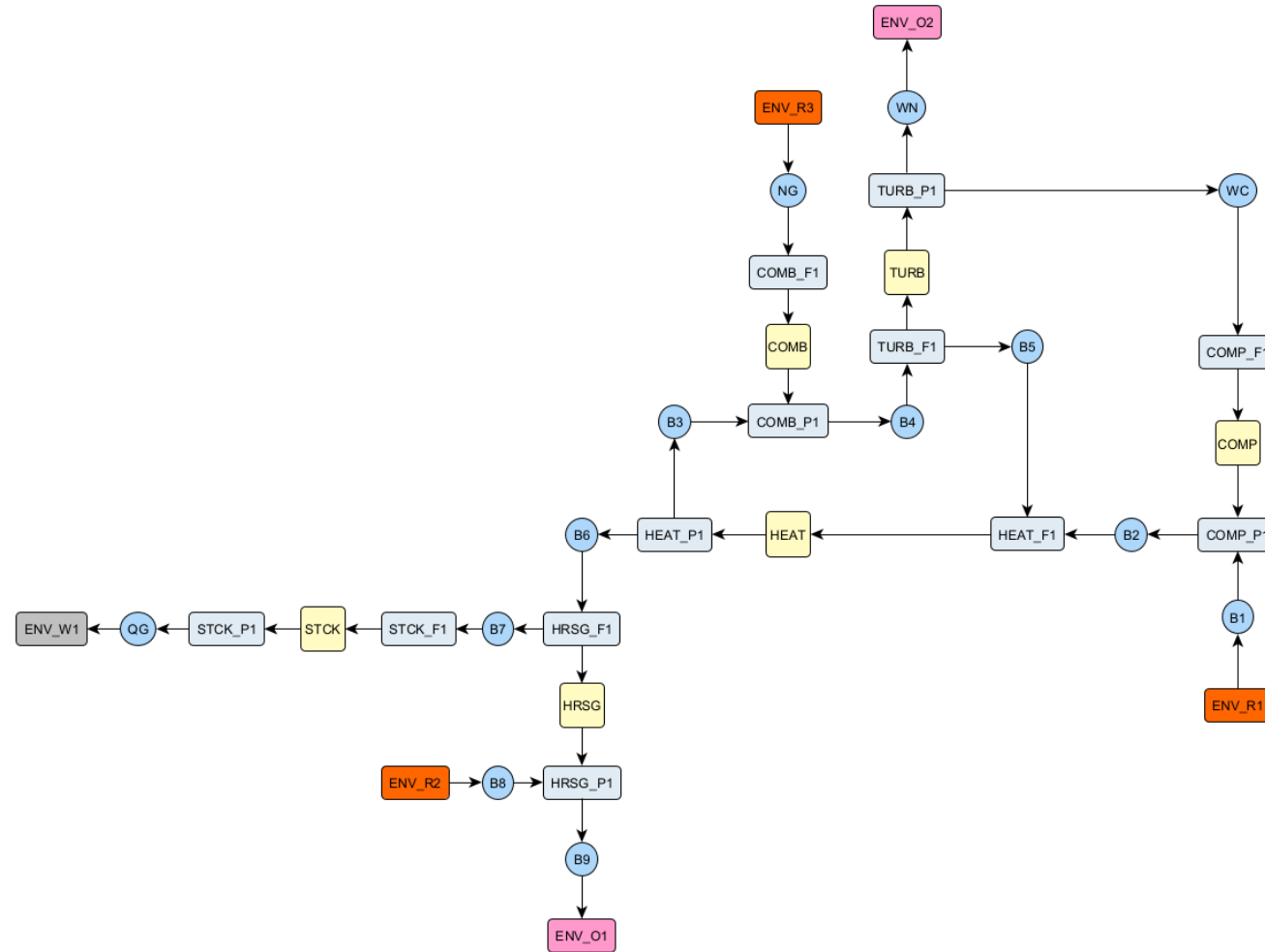

# Thermoeconomic State Results

- Shows the productive structure exergy values of the current state:
  - Flows and productive groups for the current state (**eflows**, **estreams**)
  - The exergy balance of the processes. (**eprocesses**)
  - The Fuel-Product table and diagram (**tfp**)
- When data model is loaded the values for the first state appears
- The values change when change the current state.

# Thermoeconomic State Results

The screenshot displays the TAES Lab software interface. The window title is "TAES Lab" and it has a menu bar with "File" and "Help".

**Input Parameters:**

- Data Model: cgam\_model.xlsx
- Reference State: REF
- Operation State: REF
- Resources Cost: Base
- Cost Tables: DIRECT
- Diagnosis Method: WASTE\_OUTPUT
- Results File: ModelResults.xlsx
- Summary Results:

**Buttons:** Load Data, Save Results

**Navigation:** Welcome, Tables, Graphs, Log

**Thermoeconomic State Table:**

	Description
<b>eflows</b>	Flows Exergy Table
<b>estreams</b>	Productive Groups Exergy Table
<b>eprocesses</b>	Processes Exergy Table
<b>tfp</b>	FP Table

**Result Tables Sidebar:**

- PS Productive Structure
- TS Thermoeconomic State
  - eflows
  - estreams
  - eprocesses
  - tfp
- TA Thermoeconomic Analysis
- TD Thermoeconomic Diagnosis
- SR Summary Results

**Status Bar:** INFO: Valid Data Model [www.exergoecology.com](http://www.exergoecology.com)



# Thermoeconomic State Results

The screenshot displays the TAES Lab software interface. The window title is "TAES Lab" and it has a menu bar with "File" and "Help".

**Input Parameters:**

- Data Model: cgam\_model.xlsx
- Reference State: REF
- Operation State: REF
- Resources Cost: Base
- Cost Tables: DIRECT
- Diagnosis Method: WASTE\_OUTPUT
- Results File: ModelResults.xlsx
- Summary Results:

**Process Exergy Table:**

	F(MW)	P(MW)	I(MW)	k(J/J)	$\eta$ (%)
COMB	82.711	57.022	25.689	1.4505	68.94
COMP	31.096	28.511	2.585	1.0907	91.69
TURB	63.772	61.096	2.676	1.0438	95.80
PHTR	20.939	18.735	2.204	1.1176	89.47
HRSR	17.465	12.626	4.839	1.3833	72.29
STCK	2.092	2.092	0.000	1.0000	100.00
ENV	82.711	42.626	40.085	1.9404	51.54

**Result Tables:**

- PS Productive Structure
- TS Thermoeconomic State
  - eflows
  - estreams
  - eprocesses**
  - tfp
- TA Thermoeconomic Analysis
- TD Thermoeconomic Diagnosis
- SR Summary Results

**Buttons:** Load Data, Save Results

**Footer:** INFO: Thermoeconomic State for State REF. [www.exergoecology.com](http://www.exergoecology.com)

# Thermoeconomic Analysis Results

- Calculate the direct and generalized cost of flows and processes.
- Analyse the cost formation process of products and waste.
- When data model is load appears the values for the first state defined
- You can select the tables to shown:
  - **DIRECT**: Shows the direct cost tables (default)
  - **GENERALIZED**: Shows only the generalized cost tables
  - **ALL**: Show both types of tables
- The results change when changes the current state or the cost tables to shown.

# Thermoeconomic Analysis Results

The screenshot displays the TAES Lab software interface. On the left, the 'Input Parameters' panel includes fields for Data Model (cgam\_model.xlsx), Reference State (REF), Operation State (REF), Resources Cost (Base), Cost Tables (ALL), Diagnosis Method (WASTE\_OUTPUT), Results File (ModelResults.xlsx), and a Summary Results checkbox. The main area features a 'Thermoeconomic Analysis' table with columns for code and description. A tooltip 'Show the results as tables' is visible over the table. The right sidebar, 'Result Tables', lists various results including Productive Structure, Thermoeconomic State, and Thermoeconomic Analysis, with sub-items like dcost, ducost, dfcost, etc. The bottom right corner contains the website [www.exergoecology.com](http://www.exergoecology.com).

	Description
dcost	Process Exergy Cost
ducost	Process Unit Exergy Cost
dfcost	Flows Exergy Cost
dcfp	FP Exergy Cost Table
dcfpr	FPR Exergy Cost Table
dict	Irreversibility-Cost Table
dfict	Flows Irreversibility-Cost Table
wa	Waste Allocation Table
gcost	Process Generalized Cost
gucost	Process Generalized Unit Cost
gfcost	Flows Generalized Cost
gict	Generalized Irreversibility-Cost Table
gfict	Flows Generalized Irreversibility-Cost Table
gcfp	FP Generalized Exergy Cost Table

# Thermoeconomic Analysis Results

TAES Lab
— □ ×

File
Help

**Input Parameters**

Data Model:

Reference State:

Operation State:

Resources Cost:

Cost Tables:

Diagnosis Method:

Results File:

Summary Results:

Welcome
Tables
Graphs
Log

**Flows Generalized Cost**

	B(MW)	C(\$/h)	CE(\$/h)	Cz(\$/h)	Cr(\$/h)	c(\$/MWh)	ce(\$/MWh)	cz(\$/MWh)	cr(\$/MWh)
NG	82.711	1654.220	1654.220	0.000	0.000	20.000	20.000	0.000	0.000
B1	0.000	0.000	0.000	0.000	0.000	0.000	0.000	0.000	0.000
B2	28.511	1216.575	1055.467	106.645	54.463	42.670	37.020	3.740	1.910
B3	47.246	1985.488	1736.360	159.373	89.755	42.024	36.751	3.373	1.900
B4	104.268	3699.723	3390.580	162.973	146.169	35.483	32.518	1.563	1.402
B5	40.496	1436.912	1316.846	63.296	56.770	35.483	32.518	1.563	1.402
B6	19.557	693.938	635.953	30.568	27.416	35.483	32.518	1.563	1.402
B7	2.092	74.230	68.028	3.270	2.933	35.483	32.518	1.563	1.402
B8	0.000	0.000	0.000	0.000	0.000	0.000	0.000	0.000	0.000
B9	12.626	648.708	567.926	56.298	24.484	51.379	44.981	4.459	1.939
WN	30.000	1136.612	1018.267	71.532	46.814	37.887	33.942	2.384	1.560
WC	31.096	1178.137	1055.467	74.145	48.524	37.887	33.942	2.384	1.560
QG	2.092	74.230	68.028	3.270	2.933	35.483	32.518	1.563	1.402

**Result Tables**

- ▶ PS Productive Structure
- ▶ TS Thermoeconomic State
- ▼ TA Thermoeconomic Analysis
  - dcost
  - ducost
  - dfcost
  - dcfp
  - dcfpr
  - dict
  - dfict
  - wa
  - gcost
  - gucost
  - gfcost
  - gict
  - gfict
  - gcfp
  - TD Thermoeconomic Diagnosis
  - SR Summary Results

INFO: Thermoeconomic Analysis for State REF. [www.exergoecology.com](http://www.exergoecology.com)



# Thermoeconomic Analysis Results

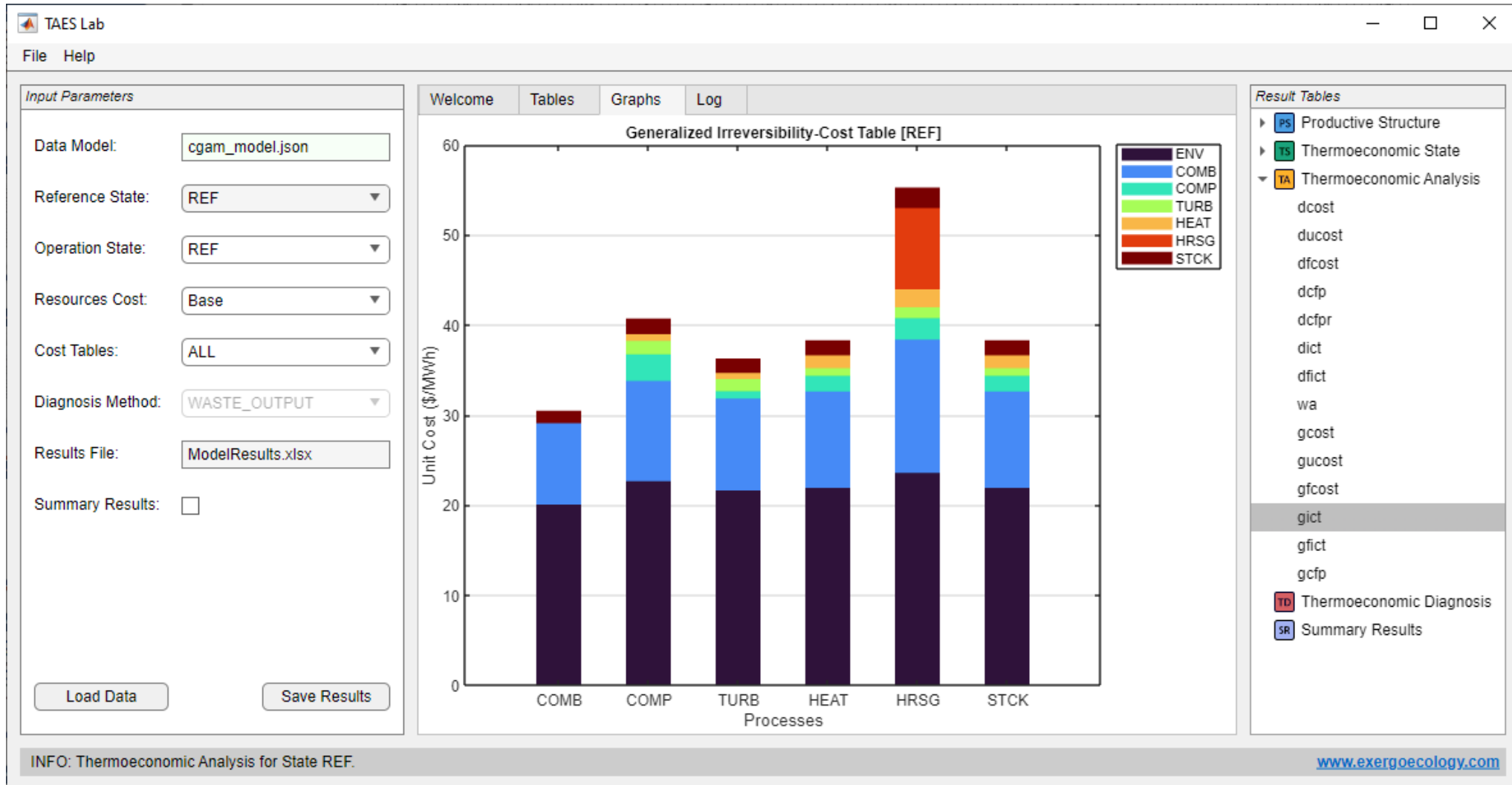

# Thermoeconomic Diagnosis Results

- TD Compares two states of the plant, identifying the malfunctions and their cost.
- Thermoeconomic diagnostics is activated by selecting an operating different from the reference state and a diagnostic method other than NONE.
- The results change when changes the current state or the reference state
- There are two calculation methods related to waste treatment:
  - WASTE\_OUTPUT: The method accounts for the variation of waste exergy and its cost.
  - WASTE\_INPUT: The method internalises the waste cost variation according to the waste internalisation method.
  - NONE: Deactivate the thermoeconomic diagnosis

# Thermoeconomic Diagnosis Results

The screenshot displays the TAES Lab software interface. The window title is "TAES Lab" and it includes a menu bar with "File" and "Help".

**Input Parameters:**

- Data Model: cgam\_model.xlsx
- Reference State: REF
- Operation State: ETG87
- Resources Cost: Base
- Cost Tables: DIRECT
- Diagnosis Method: WASTE\_INTERNAL
- Results File: ModelResults.xlsx
- Summary Results:

**Buttons:** Load Data, Save Results

**Thermoeconomic Diagnosis Table:**

	Description
dgn	Diagnosis Summary
mf	Malfunction Table
mfc	Malfunction Cost Table
dit	Irreversibility Variation Table

**Result Tables:**

- PS Productive Structure
- TS Thermoeconomic State
- TA Thermoeconomic Analysis
- TD Thermoeconomic Diagnosis
  - dgn
  - mf
  - mfc
  - dit
- SR Summary Results

[www.exergoecology.com](http://www.exergoecology.com)

# Thermoeconomic Diagnosis Results

The screenshot displays the TAES Lab software interface. The window title is "TAES Lab" and it includes a menu bar with "File" and "Help". The interface is divided into several sections:

- Input Parameters:** A panel on the left containing various settings:
  - Data Model:
  - Reference State:
  - Operation State:
  - Resources Cost:
  - Cost Tables:
  - Diagnosis Method:
  - Results File:
  - Summary Results:
- Diagnosis Summary:** A central table with columns for MF(MW), ΔI(MW), ΔPs(MW), MF\*(MW), MR\*(MW), and ΔPs\*(MW). The rows represent different components: COMB, COMP, TURB, PHTR, HRSG, STCK, and ENV.
- Result Tables:** A sidebar on the right with a tree view showing a hierarchy of results: Productive Structure, Thermoeconomic State, Thermoeconomic Analysis, and Thermoeconomic Diagnosis (expanded to show 'dgn', 'mf', 'mfc', 'dit', and 'Summary Results').
- Buttons:** "Load Data" and "Save Results" are located at the bottom left. A "Show the results as tables" button is centered below the summary table.
- Status Bar:** At the bottom, it displays "INFO: Thermoeconomic Diagnosis for State ETG87. Fuel Impact: 1.2530 (MW)" and the website "www.exergoecology.com".



# Thermoeconomic Diagnosis Results

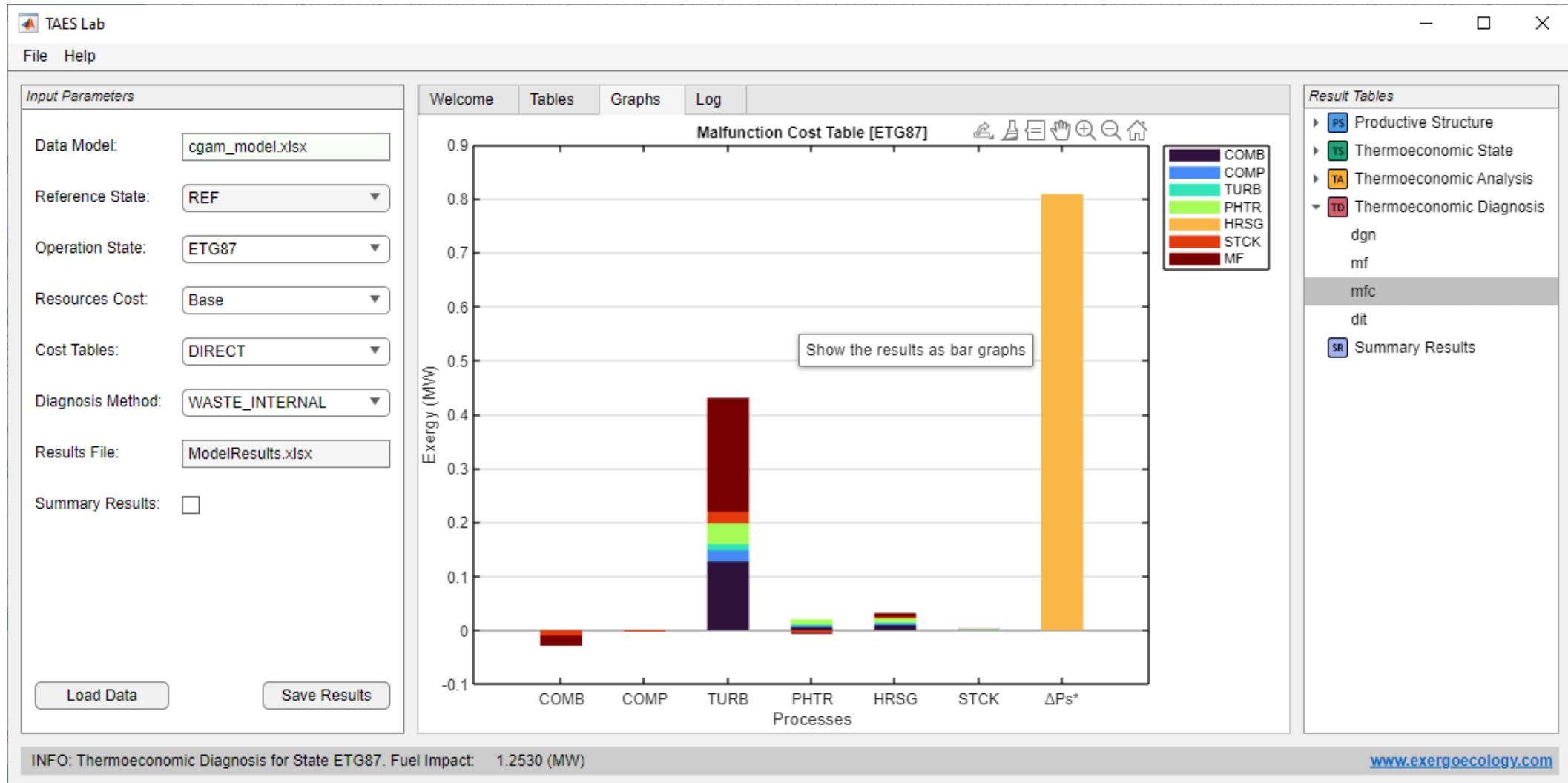

# Summary Results

- This functionality is activated by selecting the **Summary Results** check box.
- It allows to obtain comparative tables of costs for the different defined states of the plant:
  - Direct exergy costs of flows.
  - Direct exergy costs of processes.
  - Generalised costs of flows (if defined).
  - Generalised process costs (if defined).
- Comparative graphs of the plant's output flows

# Summary Results

The screenshot displays the TAES Lab software interface. The window title is "TAES Lab" and it includes a menu bar with "File" and "Help". The interface is divided into several sections:

- Input Parameters:** A panel on the left containing several input fields and dropdown menus:
  - Data Model:
  - Reference State:
  - Operation State:
  - Resources Cost:
  - Cost Tables:
  - Diagnosis Method:
  - Results File:
  - Summary Results:
- Summary Results:** A central panel with tabs for "Welcome", "Tables", "Graphs", and "Log". The "Tables" tab is active, showing a table with the following data:

	Description
exergy	Flows Exergy
pku	Process Unit Consumption
dpc	Processes Direct Exergy Cost
dpuc	Processes Direct Unit Exergy Cost
dfc	Flows Direct Exergy Cost
dfuc	Flows Direct Unit Exergy Cost
gpc	Processes Generalized Cost
gpuc	Processes Generalized Unit Cost
gfc	Flows Generalized Cost
gfuc	Flows Generalized Unit Cost
- Result Tables:** A panel on the right showing a tree view of result tables:
  - PS Productive Structure
  - TS Thermoecomic State
  - TA Thermoecomic Analysis
  - TD Thermoecomic Diagnosis
  - SR Summary Results
    - exergy
    - pku
    - dpc
    - dpuc
    - dfc
    - dfuc
    - gpc
    - gpuc
    - gfc
    - gfuc

At the bottom of the interface, there are two buttons: "Load Data" and "Save Results". The website address [www.exergoecology.com](http://www.exergoecology.com) is displayed in the bottom right corner.

# Summary Results

TAES Lab
— □ ×

File Help

*Input Parameters*

Data Model:

Reference State:

Operation State:

Resources Cost:

Cost Tables:

Diagnosis Method:

Results File:

Summary Results:

Welcome   Tables   Graphs   Log

**Flows Generalized Unit Cost (\$/MWh)**

	REF	T1180	ETG87	ECMP84	RP84	PINCH10	CGAMR
NG	20.000	20.000	20.000	20.000	20.000	20.000	20.000
B1	0.000	0.000	0.000	0.000	0.000	0.000	0.000
B2	42.670	43.050	42.946	43.018	42.725	42.760	67.957
B3	42.024	42.420	42.235	42.276	42.072	42.114	67.172
B4	35.483	35.785	35.607	35.595	35.516	35.549	54.040
B5	35.483	35.785	35.607	35.595	35.516	35.549	54.040
B6	35.483	35.785	35.607	35.595	35.516	35.549	54.040
B7	35.483	35.785	35.607	35.595	35.516	35.549	54.040
B8	0.000	0.000	0.000	0.000	0.000	0.000	0.000
B9	51.379	51.736	51.571	51.568	51.408	51.651	0.000
WN	37.887	38.229	38.140	38.003	37.917	37.960	58.544
WC	37.887	38.229	38.140	38.003	37.917	37.960	58.544
QG	35.483	35.785	35.607	35.595	35.516	35.549	54.040

*Result Tables*

- ▶ PS Productive Structure
- ▶ TS Thermoeconomic State
- ▶ TA Thermoeconomic Analysis
- ▶ TD Thermoeconomic Diagnosis
- ▼ SR Summary Results
  - exergy
  - pku
  - dpc
  - dpuc
  - dfc
  - dfuc
  - gpc
  - gpuc
  - gfc
  - gfuc

Show the results as tables

INFO: Summary Results for State ETG87.
[www.exergoecology.com](http://www.exergoecology.com)



# Summary Results

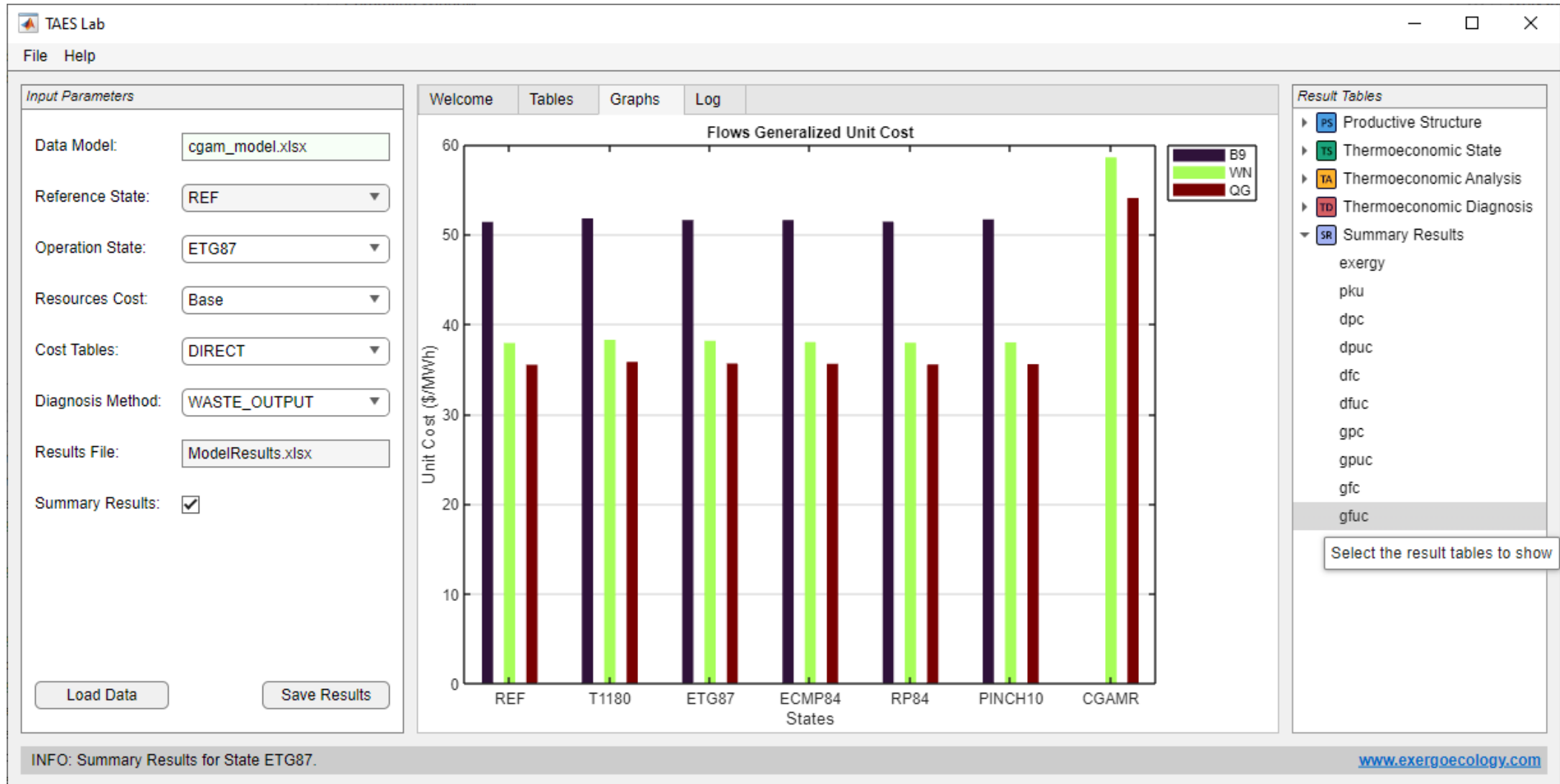

# Save Results

- The results obtained can be saved in different formats:
  - Excel (\*.xlsx)
  - Comma-separated text format (\*.csv)
  - Text format (\*.txt)
- The following results can be saved:
  - Results associated to a plant state
  - Cost summary
  - Input data model
  - Tables of the FP diagram, to be used in yEd
- The different results can be saved from the menu **File > Save**
- The model results associated to a plant state can also be saved with the **Save** button.

# Save Results

The screenshot shows the TAES Lab software interface. The 'File' menu is open, and the 'Save' option is highlighted. A sub-menu is visible, with 'Results' selected. The main window displays a 'Malfunction Cost Table (MW)' with the following data:

	COMB	COMP	TURB	HEAT	HRSG	STCK	DCPs
COMB	0.0000	-0.0000	0.1267	0.0053	0.0090	0.0007	0.0000
COMP	0.0000	-0.0000	0.0208	0.0032	0.0031	0.0003	0.0000
TURB	0.0000	-0.0000	0.0118	0.0018	0.0018	0.0002	0.0000
HEAT	0.0000	-0.0000	0.0380	0.0093	0.0082	0.0009	0.0000
HRSG	0.0000	0.0000	0.0000	0.0000	0.0000	0.0000	0.8097
STCK	-0.0137	-0.0000	0.0175	0.0007	0.0012	0.0001	0.0000
MF	-0.0188	-0.0000	0.2109	-0.0025	0.0070	0.0000	0.0000
Total	-0.0325	-0.0001	0.4257	0.0178	0.0302	0.0022	0.8097

The interface also includes a 'Result Tables' sidebar on the right, showing a tree view of results. The 'mfc' table is currently selected. The status bar at the bottom indicates: 'INFO: Thermo-economic Diagnosis for State ETG87. Fuel Impact: 1.2530 (MW)'. The website [www.exergoecology.com](http://www.exergoecology.com) is also visible in the status bar.

# Save Results

**Input Parameters**

Data Model:

Reference State:

Operation State:

Resources Cost:

Cost Tables:

Diagnosis Method:

Results File:

Summary Results:

**Select File**

« Examples » cgam

Organizar Nueva carpeta

Nombre	Fecha de modificación	Tipo
cgam_model_csv	11/04/2023 14:29	Carpeta de archivos
cgam_analysis.xlsx	11/04/2023 13:41	Hoja de cálculo d...
cgam_diagnosis.xlsx	11/04/2023 13:41	Hoja de cálculo d...
cgam_model.xlsx	11/04/2023 13:41	Hoja de cálculo d...

Nombre:

Tipo:

**Result Tables**

- PS Productive Structure
- TS Thermo-economic State
- TA Thermo-economic Analysis
- TD Thermo-economic Diagnosis
  - dgn
  - mf
  - mfc**
  - dit
- SR Summary Results

COMB COMP TURB HEAT HRSG STCK DCPs

Processes

INFO: Thermo-economic Diagnosis for State ETG87. Fuel Impact: 1.2530 (MW) [www.exergoecology.com](http://www.exergoecology.com)



# Appendix: List of Tables and Graphs

## PS Productive Structure

- **flows:** Information about the flows of the plant, indicating the productive group of origin and destination.
- **streams:** Information about the productive groups that have been defined.
- **processes:** Information about the plant's processes

## TS Thermoeconomic State

- **eflows:** Flows Exergy
- **estreams:** Exergy associated to the productive groups
- **eprocesses:** Exergy of fuel and product and irreversibility of each process as well as its energy consumption.
- **tfp:** Fuel-Product Table(\*)

# Flows Exergy Table (eflows)

Key	From	To	B(MW)
B1	ENV_R1	COMP_P1	0.000
B2	COMP_P1	HEAT_P1	28.511
B3	HEAT_P1	COMB_P1	47.246
B4	COMB_P1	TURB_F1	104.268
B5	TURB_F1	HEAT_F1	40.496
B6	HEAT_F1	HRSG_F1	19.557
B7	HRSG_F1	STCK_F1	2.092
B8	ENV_R2	HRSG_P1	0.000
B9	HRSG_P1	ENV_O1	12.626
WN	TURB_P1	ENV_O2	30.000
WC	TURB_P1	COMP_F1	31.096
NG	ENV_R3	COMB_F1	82.711
QG	STCK_P1	ENV_W1	2.092

# Process Exergy Table (eprocesses)

Key	F (MW)	P (MW)	I (MW)	k (J/J)
COMB	82.711	57.022	25.689	1.4505
COMP	31.096	28.511	2.585	1.0907
TURB	63.772	61.096	2.676	1.0438
HEAT	20.939	18.735	2.204	1.1176
HRSG	17.465	12.626	4.839	1.3833
STCK	2.092	2.092	0.000	1.0000

# Fuel-Product Table(tfp)

Key (MW)	COMB	COMP	TURB	HEAT	HRSG	STCK	ENV	Total
COMB	0.000	0.000	34.876	11.451	9.551	1.144	0.000	57.022
COMP	0.000	0.000	17.438	5.726	4.776	0.572	0.000	28.511
TURB	0.000	31.096	0.000	0.000	0.000	0.000	30.000	61.096
HEAT	0.000	0.000	11.459	3.762	3.138	0.376	0.000	18.735
HRSG	0.000	0.000	0.000	0.000	0.000	0.000	12.626	12.626
STCK	0.000	0.000	0.000	0.000	0.000	0.000	2.092	2.092
ENV	82.711	0.000	0.000	0.000	0.000	0.000	0.000	82.711
Total	82.711	31.096	63.772	20.939	17.465	2.092	44.718	0.000

## TA Thermoeconomic Analysis

- **dcost:** Processes Cost
- **ducost:** Unit Cost of Processes
- **dfcost:** Flows Cost
- **dcfp:** Fuel-Product Cost Table (\*)
- **dcfpr:** Fuel-Product-Waste Cost Table
- **dict:** Irreversibility-Cost Table of Processes (\*)
- **dfict:** Irreversibility-Cost Table of Flows (\*)

- Tables with (\*) have associated graphs.
- Tables starting with (**d**) refer to direct exergy costs and those starting with (**g**) to generalised exergy costs.

## TD Thermoeconomic Diagnosis

- **dgn:** Diagnosis Summary Table
- **mf:** Malfunction Table(\*)
- **mfc:** Malfunction Cost Table (\*)
- **dit:** Irreversibility Variation Table (\*)

## Direct Cost of Processes (dcost)

Key	P* (MW)	Pe* (MW)	Pr* (MW)	F* (MW)	R* (MW)
COMB	85.402	82.711	2.691	82.711	2.691
COMP	55.372	52.773	2.598	55.088	0.283
TURB	108.235	103.687	4.548	107.952	0.283
HEAT	35.728	34.045	1.684	35.445	0.283
HRSO	29.564	28.396	1.168	29.564	0.000
STCK	3.541	3.401	0.140	3.541	0.000

# Direct Unit Cost of Processes (ducost)

Key	KP* (J/J)	kPe* (J/J)	kPr* (J/J)	kF* (J/J)	kR* (J/J)	k (J/J)
COMB	1.4977	1.4505	0.0472	1.0000	0.0472	1.4505
COMP	1.9421	1.8510	0.0911	1.7716	0.0099	1.0907
TURB	1.7716	1.6971	0.0744	1.6928	0.0046	1.0438
HEAT	1.9070	1.8172	0.0899	1.6928	0.0151	1.1176
HRSG	2.3415	2.2490	0.0925	1.6928	0.0000	1.3833
STCK	1.6928	1.6259	0.0669	1.6928	0.0000	1.0000

# Direct Cost of Processes Tables Info

$P^*$  : Product Cost

$F^*$  : Fuel Cost

$R^*$  : External Irreversibility Cost

$$P^* = F^* + R^*$$

$kP^*$  : Product Unit Cost

$kF^*$  : Fuel Unit Cost

$kR^*$  : External Irreversibility Unit Cost

$P_e^*$ : Product Cost due to Internal Irreversibilities

$P_r^*$ : Product Cost due to External Irreversibilities

$$P^* = P_e^* + P_r^*$$

$kP_e^*$ : Product Unit Cost due to Internal Irreversibilities

$kP_r^*$ : Product Unit Cost due to External Irreversibilities

$$kP^* = kP_e^* + kP_r^*$$



# Direct Cost of Flows Table(dfcost)

Key	B(MW)	B*(MW)	Be*(MW)	Br*(MW)	k*(J/J)	ke*(J/J)	kr*(J/J)
B1	0.000	0.000	0.000	0.000	1.0000	1.0000	0.0000
B2	28.511	55.372	52.773	2.598	1.9421	1.8510	0.0911
B3	47.246	91.100	86.818	4.282	1.9282	1.8376	0.0906
B4	104.268	176.502	169.529	6.973	1.6928	1.6259	0.0669
B5	40.496	68.551	65.842	2.708	1.6928	1.6259	0.0669
B6	19.557	33.106	31.798	1.308	1.6928	1.6259	0.0669
B7	2.092	3.541	3.401	0.140	1.6928	1.6259	0.0669
B8	0.000	0.000	0.000	0.000	1.0000	1.0000	0.0000
B9	12.626	29.564	28.396	1.168	2.3415	2.2490	0.0925
WN	30.000	53.147	50.913	2.233	1.7716	1.6971	0.0744
WC	31.096	55.088	52.773	2.315	1.7716	1.6971	0.0744
NG	82.711	82.711	82.711	0.000	1.0000	1.0000	0.0000
QG	2.092	0.000	3.401	0.140	1.6928	1.6259	0.0669

## Direct Cost of Flows Table Info

$B^*$  : Exergy Cost

$Be^*$  : Exergy Cost due to internal irreversibilities

$Br^*$  : Exergy Cost due to external irreversibilities

$$B^* = Be^* + Br^*$$

$k^*$  : Unit Exergy Cost

$ke^*$  : Unit Exergy Cost due to internal irreversibilities

$kr^*$  : Unit Exergy Cost due to external irreversibilities

$$k^* = ke^* + kr^*$$

# Fuel-Product-Waste Cost Table (dcfpr)

Key (MW)	COMB	COMP	TURB	HEAT	HRSG	STCK	ENV	Total
COMB	0.0000	0.0000	52.2335	17.1504	14.3050	1.7135	0.0000	85.4024
COMP	0.0000	0.0000	33.8662	11.1197	9.2748	1.1110	0.0000	55.3716
TURB	0.0000	55.0883	0.0000	0.0000	0.0000	0.0000	53.1467	108.2350
HEAT	0.0000	0.0000	21.8520	7.1749	5.9845	0.7168	0.0000	35.7283
HRSG	0.0000	0.0000	0.0000	0.0000	0.0000	0.0000	29.5643	29.5643
STCK	2.6914	0.2833	0.2833	0.2833	0.0000	0.0000	0.0000	3.5413
ENV	82.7110	0.0000	0.0000	0.0000	0.0000	0.0000	0.0000	82.7110
Total	85.4024	55.3716	108.2350	35.7283	29.5643	3.5413	82.7110	0.0000

# Irreversibility Cost Table (dict)

Key	COMB	COMP	TURB	HEAT	HRSG	STCK
COMB	0.4505	0.5749	0.5271	0.5644	0.6985	0.5050
COMP	0.0000	0.1485	0.0530	0.0568	0.0703	0.0508
TURB	0.0000	0.0783	0.0717	0.0299	0.0370	0.0268
HEAT	0.0000	0.0493	0.0452	0.1661	0.0599	0.0433
HRSG	0.0000	0.0000	0.0000	0.0000	0.3833	0.0000
STCK	0.0472	0.0911	0.0744	0.0899	0.0925	0.0669
ENV	1.0000	1.0000	1.0000	1.0000	1.0000	1.0000
Total	1.4977	1.9421	1.7716	1.9070	2.3415	1.6928

# Irreversibility-Cost Graph

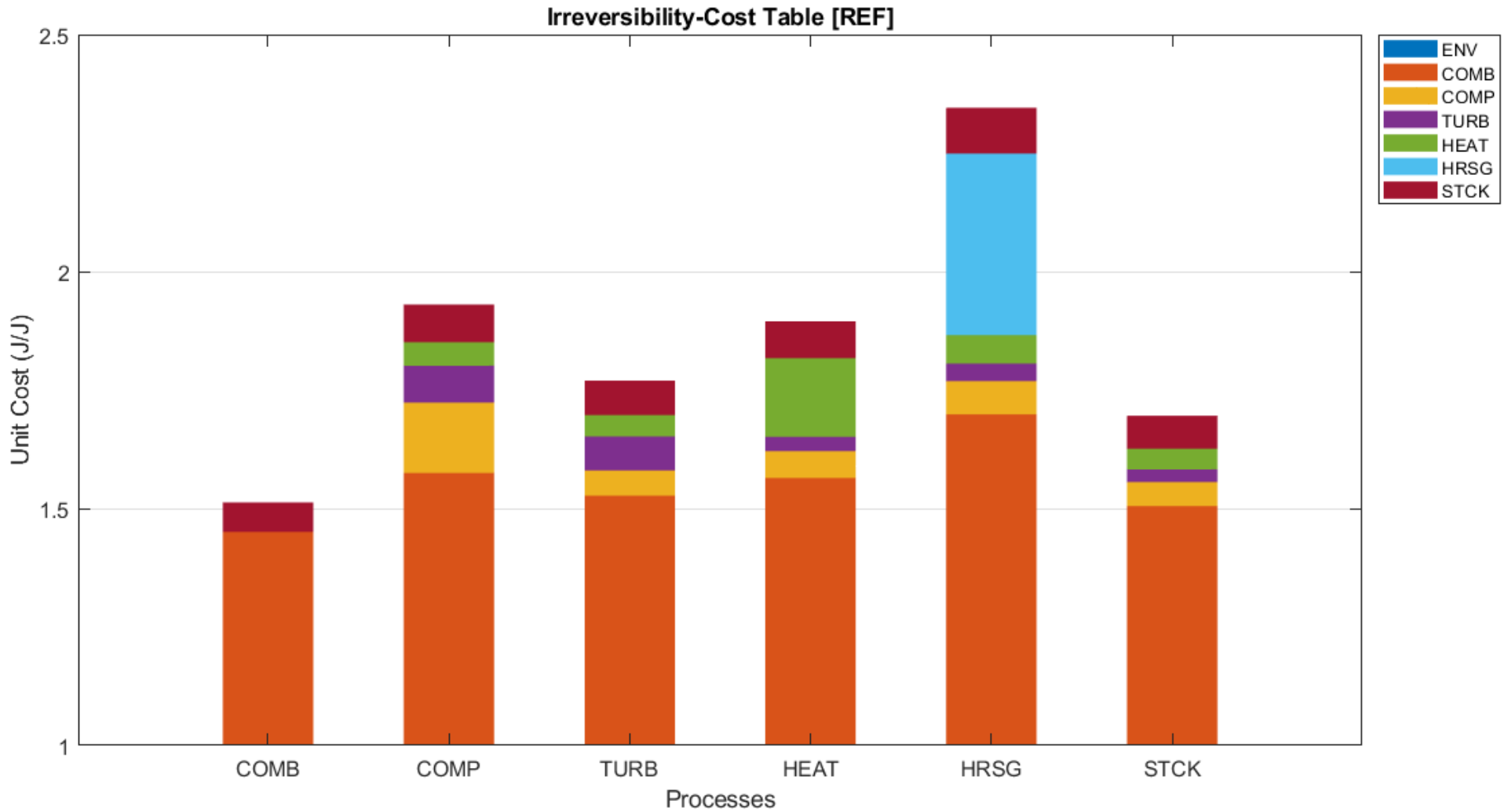

# Flows Irreversibility-Cost Table (dfict)

Key	COMB	COMP	TURB	HEAT	HRSR	STCK	ENV	Total
B1	0.0000	0.0000	0.0000	0.0000	0.0000	0.0000	1.0000	1.0000
B2	0.5749	0.1485	0.0783	0.0493	0.0000	0.0911	1.0000	1.9421
B3	0.5707	0.1121	0.0591	0.0956	0.0000	0.0906	1.0000	1.9282
B4	0.5050	0.0508	0.0268	0.0433	0.0000	0.0669	1.0000	1.6928
B5	0.5050	0.0508	0.0268	0.0433	0.0000	0.0669	1.0000	1.6928
B6	0.5050	0.0508	0.0268	0.0433	0.0000	0.0669	1.0000	1.6928
B7	0.5050	0.0508	0.0268	0.0433	0.0000	0.0669	1.0000	1.6928
B8	0.0000	0.0000	0.0000	0.0000	0.0000	0.0000	1.0000	1.0000
B9	0.6985	0.0703	0.0370	0.0599	0.3833	0.0925	1.0000	2.3415
WN	0.5271	0.0530	0.0717	0.0452	0.0000	0.0744	1.0000	1.7716
WC	0.5271	0.0530	0.0717	0.0452	0.0000	0.0744	1.0000	1.7716
NG	0.0000	0.0000	0.0000	0.0000	0.0000	0.0000	1.0000	1.0000
QG	0.5050	0.0508	0.0268	0.0433	0.0000	0.0669	1.0000	1.6928

# Flows Irreversibility-Cost Graph

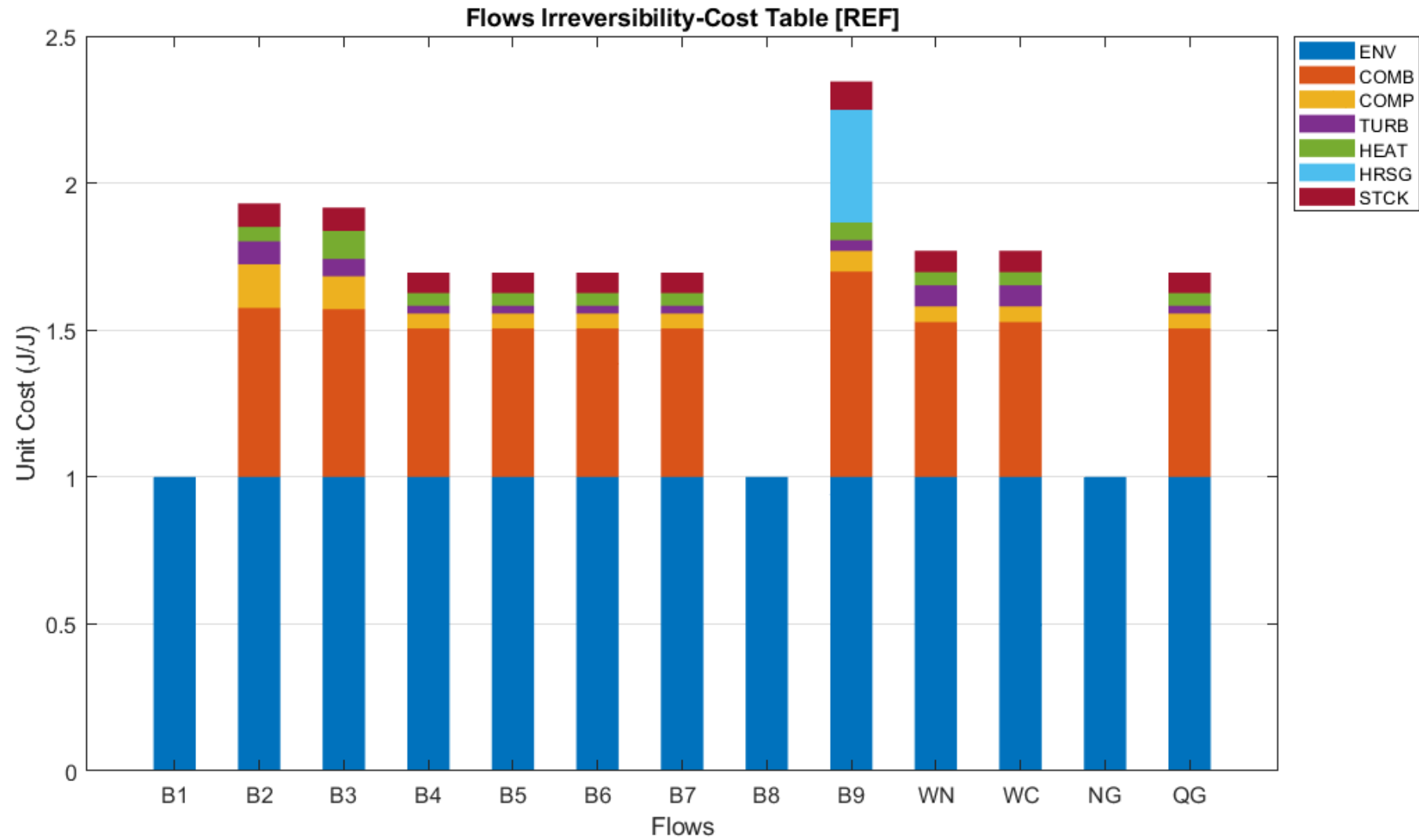

# Generalized Cost of Processes (gcost)

Key (\$/h)	CP (\$/h)	CPe (\$/h)	CPz (\$/h)	CPr (\$/h)	CF (\$/h)	CR (\$/h)	Z (\$/h)
COMB	1714.23	1654.22	3.60	56.41	1654.22	56.41	3.60
COMP	1216.58	1055.47	106.65	54.46	1178.14	5.94	32.50
TURB	2314.75	2073.73	145.68	95.34	2262.81	5.94	46.00
HEAT	768.91	680.89	52.73	35.29	742.97	5.94	20.00
HRSG	648.71	567.93	56.30	24.48	619.71	0.00	29.00
STCK	74.23	68.03	3.27	2.93	74.23	0.00	0.00



# Generalized Unit Cost of Processes (gucost)

Key	cP(\$/MWh)	cPe(\$/MWh)	cPz(\$/MWh)	cPr(\$/MWh)	cF(\$/MWh)	cR(\$/MWh)
COMB	30.0627	29.0102	0.0631	0.9894	20.0000	0.9894
COMP	42.6704	37.0197	3.7405	1.9102	37.8871	0.2083
TURB	37.8871	33.9422	2.3844	1.5605	35.4828	0.0972
HEAT	41.0415	36.3434	2.8144	1.8837	35.4828	0.3170
HRSG	51.3787	44.9807	4.4589	1.9391	35.4828	0.0000
STCK	35.4828	32.5179	1.5630	1.4019	35.4828	0.0000

# Generalised Cost of Processes Tables Info

CP : Product Cost

CF : Fuel Cost

CR : External Irreversibility Cost

Z: Process Cost

$CP=CF+CR+Z$

cP: Product Unit Cost

cF : Fuel Unit Cost

cR : External Irreversibility Unit Cost

CPe: Product Cost due to External Resources

CPz: Product Cost due to Process Resources

CPr: Product Cost due to Waste

$CP=CPe+CPz+CPr$

cPe: Product Unit Cost due External Resources

cPz: Product Unit Cost due to Process Resources

cPr: Product Unit Cost due to Waste

$cP=cPe+cPz+cPr$

# Generalized Unit Cost of Flows (gfcost)

Key	B(MW)	C(\$/h)	CE(\$/h)	Cz(\$/h)	Cr(\$/h)	c(\$/MWh)	ce(\$/MWh)	cz(\$/MWh)	cr(\$/MWh)
B1	0.00	0.00	0.00	0.00	0.00	0.0000	0.0000	0.0000	0.0000
B2	28.51	1216.58	1055.47	106.65	54.46	42.6704	37.0197	3.7405	1.9102
B3	47.25	1985.49	1736.36	159.37	89.75	42.0245	36.7515	3.3733	1.8997
B4	104.27	3699.72	3390.58	162.97	146.17	35.4828	32.5179	1.5630	1.4019
B5	40.50	1436.91	1316.85	63.30	56.77	35.4828	32.5179	1.5630	1.4019
B6	19.56	693.94	635.95	30.57	27.42	35.4828	32.5179	1.5630	1.4019
B7	2.09	74.23	68.03	3.27	2.93	35.4828	32.5179	1.5630	1.4019
B8	0.00	0.00	0.00	0.00	0.00	0.0000	0.0000	0.0000	0.0000
B9	12.63	648.71	567.93	56.30	24.48	51.3787	44.9807	4.4589	1.9391
WN	30.00	1136.61	1018.27	71.53	46.81	37.8871	33.9422	2.3844	1.5605
WC	31.10	1178.14	1055.47	74.15	48.52	37.8871	33.9422	2.3844	1.5605
NG	82.71	1654.22	1654.22	0.00	0.00	20.0000	20.0000	0.0000	0.0000
QG	2.09	0.00	68.03	3.27	2.93	35.4828	32.5179	1.5630	1.4019

# Generalised Cost of Flows

C : Flow Cost

C<sub>e</sub>: Flow Cost due to External Resources

C<sub>z</sub>: Flow Cost due to Process Resources

C<sub>r</sub>: Flow Cost due to External Irreversibilities

$$C = C_e + C_z + C_r$$

c : Flow Unit Cost

c<sub>e</sub>: Flow Unit Cost due to External Resources

c<sub>z</sub>: Flow Unit Cost due to Process Resources

c<sub>r</sub>: Flow Unit Cost due to External Irreversibilities

$$c = c_e + c_z + c_r$$

# Generalized Fuel-Product Cost Table (gcfp)

Key (\$/h)	COMB	COMP	TURB	HEAT	HRSG	STCK	ENV	Total
COMB	0.00	0.00	1048.45	344.25	287.14	34.39	0.00	1714.23
COMP	0.00	0.00	744.08	244.31	203.78	24.41	0.00	1216.58
TURB	0.00	1178.14	0.00	0.00	0.00	0.00	1136.61	2314.75
HEAT	0.00	0.00	470.28	154.41	128.79	15.43	0.00	768.91
HRSG	0.00	0.00	0.00	0.00	0.00	0.00	648.71	648.71
STCK	56.41	5.94	5.94	5.94	0.00	0.00	0.00	74.23
ENV	1657.82	32.50	46.00	20.00	29.00	0.00	0.00	1785.32
Total	1714.23	1216.58	2314.75	768.91	648.71	74.23	1785.32	

# Generalized Irreversibility-Cost Table (gict)

Key (\$/h)	COMB	COMP	TURB	HEAT	HRSR	STCK
COMB	9.0298	11.5229	10.5650	11.3124	14.0008	10.1216
COMP	0.0000	3.4169	1.2203	1.3066	1.6172	1.1691
TURB	0.0000	1.7185	1.5757	0.6572	0.8134	0.5880
HEAT	0.0000	1.0948	1.0038	3.6859	1.3302	0.9616
HRSR	0.0000	0.0000	0.0000	0.0000	8.7770	0.0000
STCK	0.9894	1.9102	1.5605	1.8837	1.9391	1.4019
ENV	20.0435	23.0071	21.9619	22.1957	22.9010	21.2406
Total	30.0627	42.6704	37.8871	41.0415	51.3787	35.4828

# Generalised Irreversibility-Cost Graph

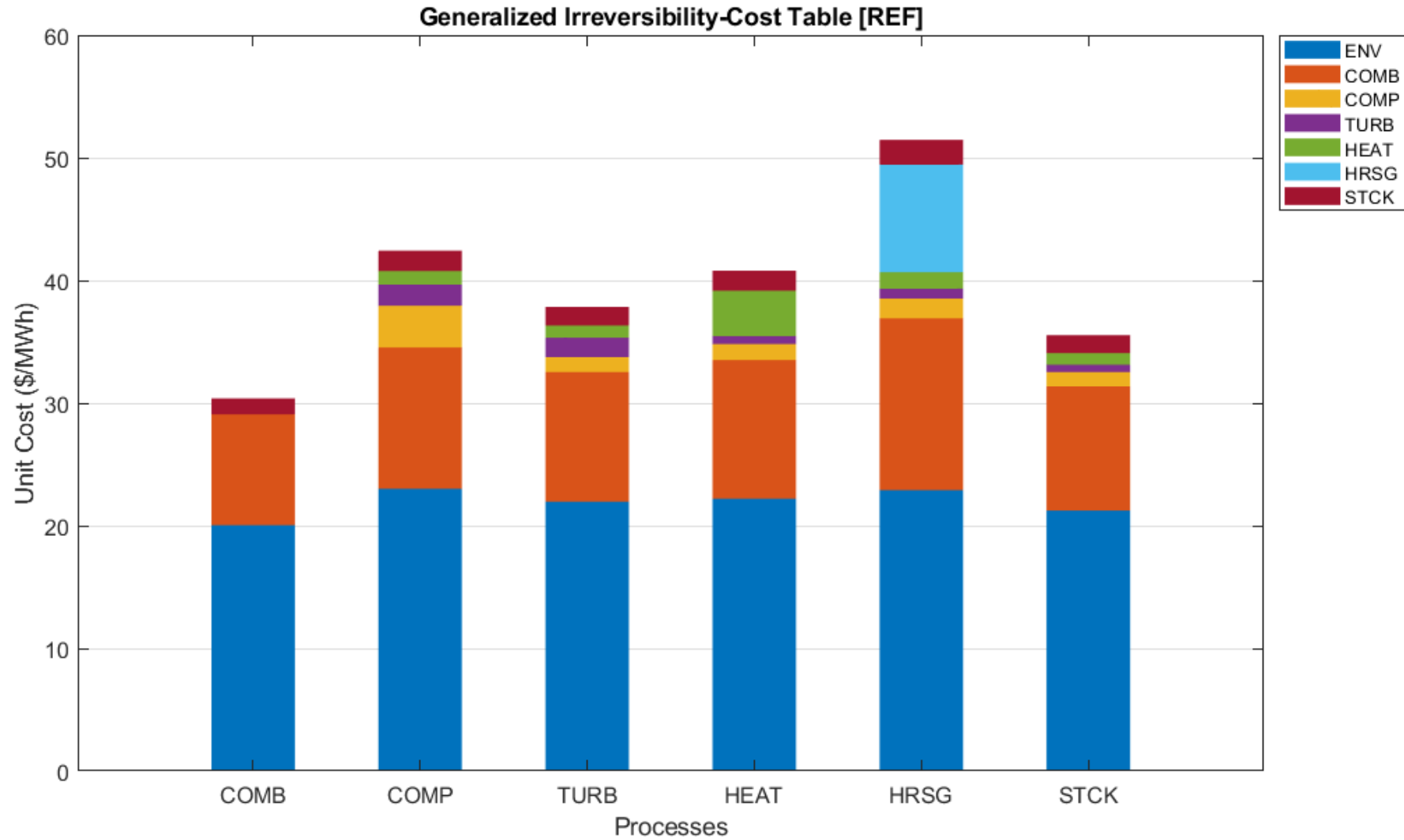

# Generalised Irreversibility-Cost Flows Table (gfict)

Key	COMB	COMP	TURB	HEAT	HRSO	STCK	ENV	Total
B1	0.0000	0.0000	0.0000	0.0000	0.0000	0.0000	0.0000	0.0000
B2	11.5229	3.4169	1.7185	1.0948	0.0000	1.9102	23.0071	42.6704
B3	11.4394	2.5801	1.2977	2.1223	0.0000	1.8997	22.6853	42.0245
B4	10.1216	1.1691	0.5880	0.9616	0.0000	1.4019	21.2406	35.4828
B5	10.1216	1.1691	0.5880	0.9616	0.0000	1.4019	21.2406	35.4828
B6	10.1216	1.1691	0.5880	0.9616	0.0000	1.4019	21.2406	35.4828
B7	10.1216	1.1691	0.5880	0.9616	0.0000	1.4019	21.2406	35.4828
B8	0.0000	0.0000	0.0000	0.0000	0.0000	0.0000	0.0000	0.0000
B9	14.0008	1.6172	0.8134	1.3302	8.7770	1.9391	22.9010	51.3787
WN	10.5650	1.2203	1.5757	1.0038	0.0000	1.5605	21.9619	37.8871
WC	10.5650	1.2203	1.5757	1.0038	0.0000	1.5605	21.9619	37.8871
NG	0.0000	0.0000	0.0000	0.0000	0.0000	0.0000	20.0000	20.0000
QG	10.1216	1.1691	0.5880	0.9616	0.0000	1.4019	21.2406	35.4828



# Generalised Irreversibility-Cost Flows Graph

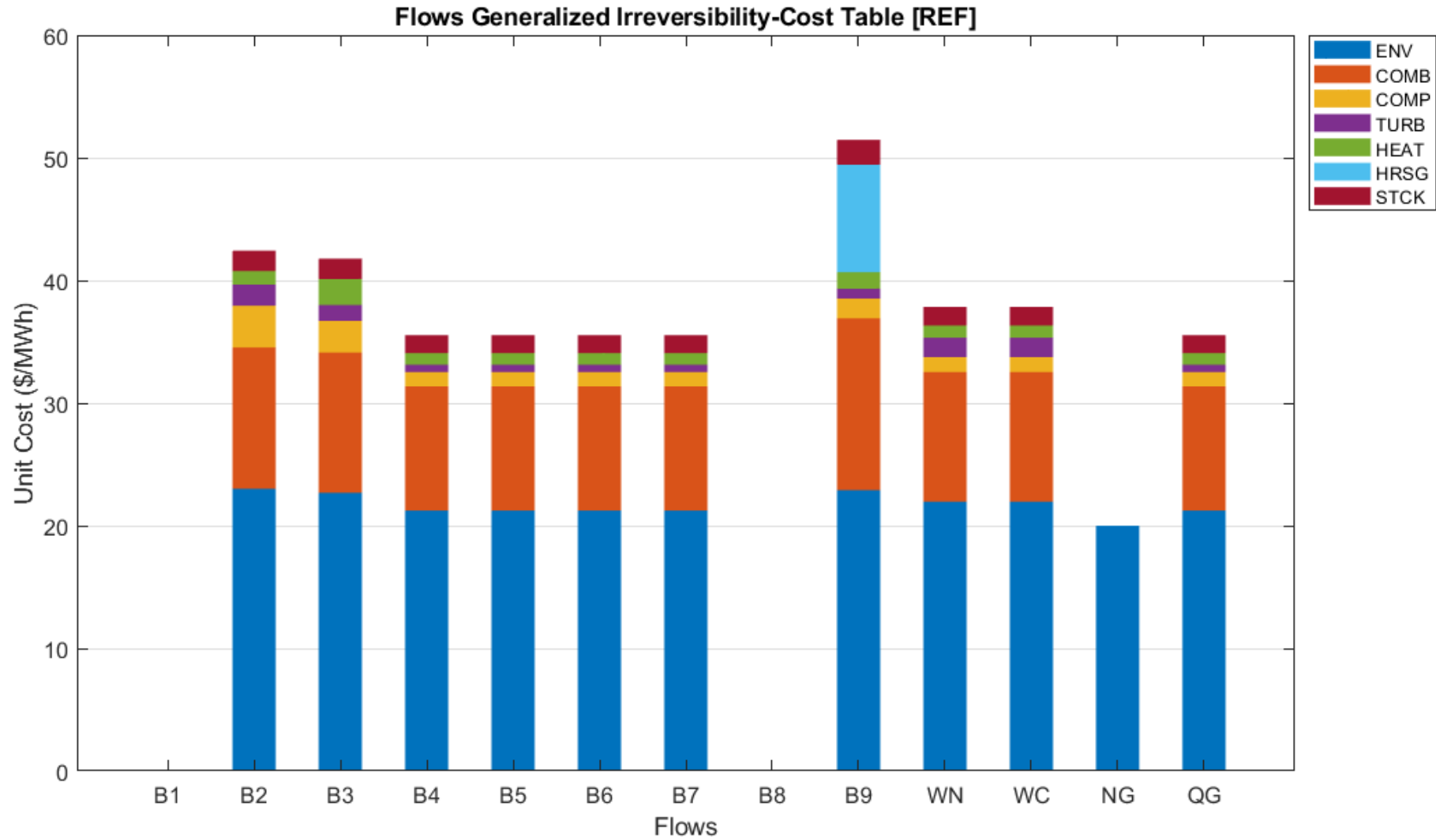

# Diagnosis Summary Table (dgn)

Key	MF (MW)	$\Delta I$ (MW)	$\Delta P_s$ (MW)	MF*(MW)	MR*(MW)	$\Delta P_s^*$ (MW)
COMB	-0.0188	0.3760	0.0000	-0.0188	-0.0145	0.0000
COMP	0.0000	0.0530	0.0000	-0.0001	0.0000	0.0000
TURB	0.2109	0.2410	0.0000	0.3785	0.0172	0.0000
HEAT	0.0175	0.0760	0.0000	0.0209	0.0009	0.0000
HRSG	0.0070	0.1390	0.3440	0.0120	0.0005	0.8563
STCK	0.0000	0.0000	0.0240	0.0000	0.0000	0.0000
Total	0.2164	0.8850	0.3680	0.3925	0.0042	0.8563

# Diagnosis Summary Table

MF: Malfunction

$\Delta I$ : Irreversibility Variation

$\Delta P_s$ : Output Variation

$\Delta F_T$ : Fuel Impact

$$\Delta F_T = \Delta I + \Delta P_s$$

MF\* : Malfunction Cost

MR\* : Waste Variation Cost

$\Delta P_s^*$ : Output Variation Cost

$$\Delta F_T = MF^* + MR^* + \Delta P_s^*$$

# Irreversibility Variation Table (dit)

(MW)	COMB	COMP	TURB	HEAT	HRSO	STCK	$\Delta P_s$
COMB	0.0000	0.0000	0.0000	0.0000	0.0000	0.0000	0.0000
COMP	0.0000	0.0000	0.0000	0.0000	0.0000	0.0000	0.0000
TURB	0.1175	0.0206	0.0117	0.0178	0.0000	0.0000	0.0000
HEAT	0.0065	-0.0065	-0.0037	0.0071	0.0000	0.0000	0.0000
HRSO	0.0037	0.0005	0.0003	0.0005	0.0000	0.0000	0.3440
STCK	0.0000	0.0000	0.0000	0.0000	0.0000	0.0000	0.0240
ENV	0.2671	0.0384	0.0218	0.0332	0.1320	0.0000	0.0000
MF	-0.0188	0.0000	0.2109	0.0175	0.0070	0.0000	0.0000
Total	0.3760	0.0530	0.2410	0.0760	0.1390	0.0000	0.3680

# Irreversibility Variation Graph

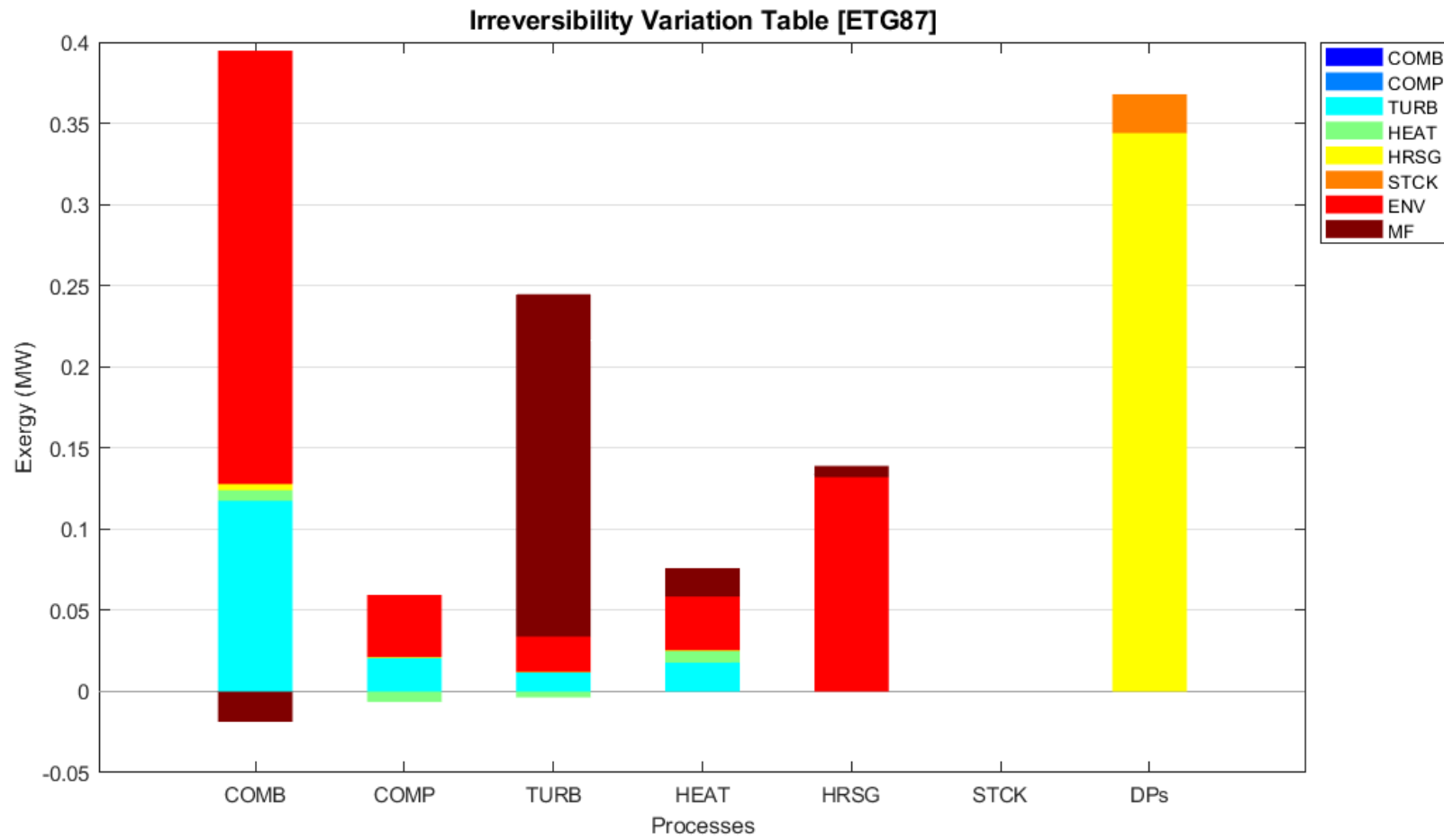

# Malfunction Table (mf)

(MW)	COMB	COMP	TURB	HEAT	HRSO	STCK	$\Delta P_s$
COMB	0.0000	0.0000	-0.0578	-0.0120	0.0000	0.0000	0.0000
COMP	0.0000	0.0000	0.0000	-0.1619	0.0000	0.0000	0.0000
TURB	0.0000	0.0000	0.0000	0.0000	0.0000	0.0000	0.0000
HEAT	0.0000	0.0000	0.2686	0.1913	0.0070	0.0000	0.0000
HRSO	0.0000	0.0000	0.0000	0.0000	0.0000	0.0000	0.3440
STCK	0.0000	0.0000	0.0000	0.0000	0.0000	0.0000	0.0240
ENV	-0.0188	0.0000	0.0000	0.0000	0.0000	0.0000	0.0000
MF	-0.0188	0.0000	0.2109	0.0175	0.0070	0.0000	0.3680

# Malfunction Cost Table (mfc)

(MW)	COMB	COMP	TURB	HEAT	HRSO	STCK	DCPs
COMB	0.0000	0.0000	0.1175	0.0065	0.0037	0.0000	0.0000
COMP	0.0000	0.0000	0.0206	-0.0065	0.0005	0.0000	0.0000
TURB	0.0000	0.0000	0.0117	-0.0037	0.0003	0.0000	0.0000
HEAT	0.0000	0.0000	0.0178	0.0071	0.0005	0.0000	0.0000
HRSO	0.0000	0.0000	0.0000	0.0000	0.0000	0.0000	0.8563
STCK	-0.0145	0.0000	0.0172	0.0009	0.0005	0.0000	0.0000
ENV	-0.0188	0.0000	0.2109	0.0175	0.0070	0.0000	0.0000
Total	-0.0333	-0.0001	0.3956	0.0219	0.0125	0.0000	0.8563

# Malfunction Cost Graph

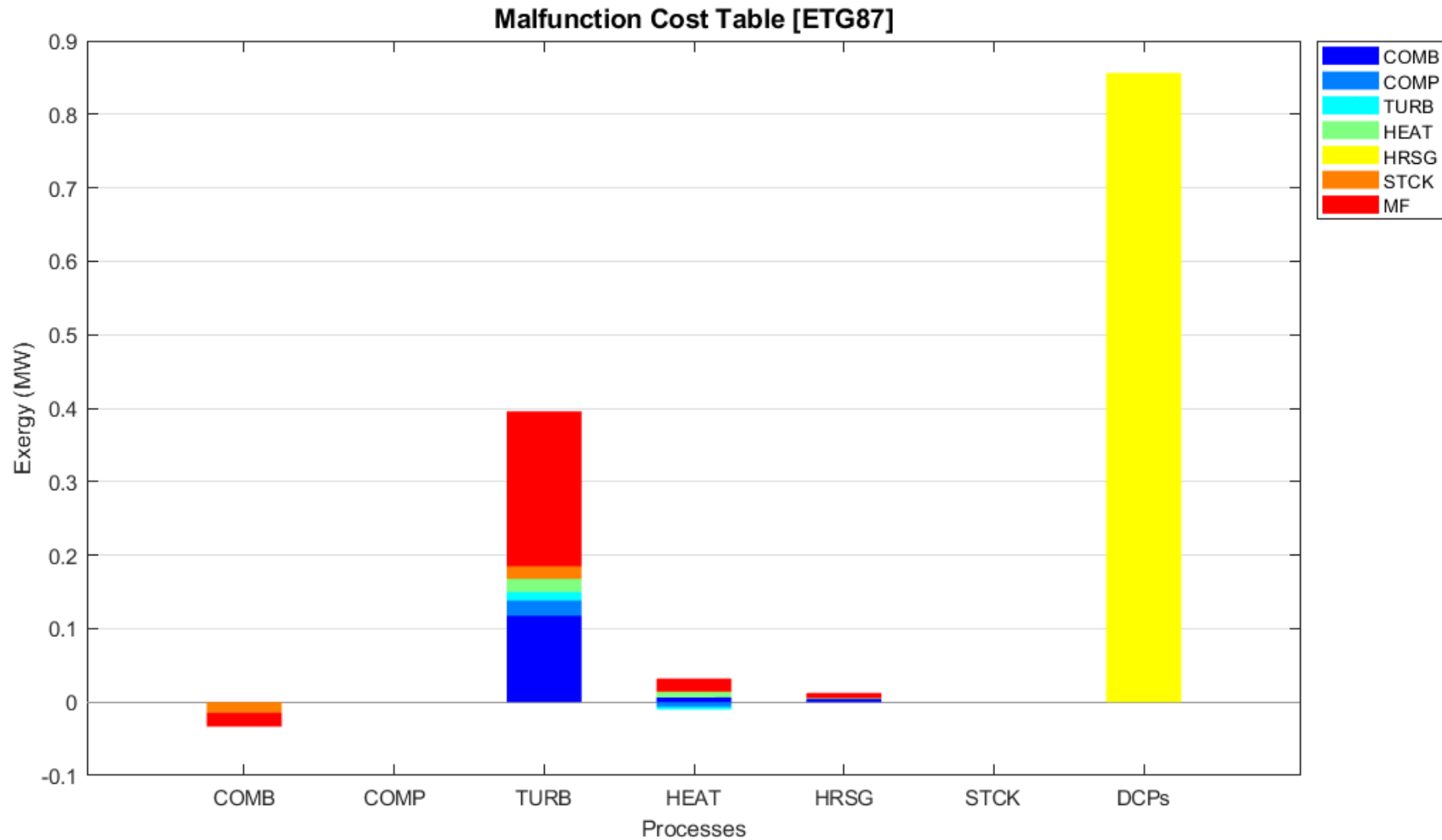



## GS Summary Results

- **exergy**: Exergy Values of flows for each state plant.
- **pku**: Unit consumption of processes
- **dpc**: Exergy Cost of Processes
- **dpuc**: Unit Exergy Cost of Processes
- **dfc**: Exergy Cost of Flows.
- **dfuc**: Unit Exergy Cost of Flows

- Tables with (\*) have associated graphs.
- Tables starting with (**d**) refer to direct exergy costs and those starting with (**g**) to generalised exergy costs.

# Unit Consumption Summary Table (pku)

Key	REF	T1180	ETG87	ECMP84	RP84	PINCH10
COMB	1.4505	1.4574	1.4502	1.4504	1.4504	1.4505
COMP	1.0907	1.0907	1.0907	1.0966	1.0911	1.0907
TURB	1.0438	1.0444	1.0473	1.0438	1.0437	1.0438
HEAT	1.1176	1.1181	1.1175	1.1166	1.1184	1.1176
HRSB	1.3833	1.3816	1.3838	1.3842	1.3828	1.3883
STCK	1.0000	1.0000	1.0000	1.0000	1.0000	1.0000

# Unit Cost of Flows Summary Table(dfuc)

Key	REF	T1180	ETG87	ECMP84	RP84	PINCH10
B1	1.0000	1.0000	1.0000	1.0000	1.0000	1.0000
B2	1.0000	1.0000	1.0000	1.0000	1.0000	1.0000
B3	1.9304	1.9475	1.9427	1.9464	1.9328	1.9341
B4	1.9164	1.9337	1.9259	1.9277	1.9189	1.9201
B5	1.6956	1.7097	1.7009	1.7005	1.6973	1.6989
B6	1.6956	1.7097	1.7009	1.7005	1.6973	1.6989
B7	1.6956	1.7097	1.7009	1.7005	1.6973	1.6989
B8	1.6956	1.7097	1.7009	1.7005	1.6973	1.6989
B9	1.0000	1.0000	1.0000	1.0000	1.0000	1.0000
WN	2.3455	2.3621	2.3537	2.3539	2.3470	2.3587
WC	1.7699	1.7856	1.7812	1.7750	1.7714	1.7733
NG	1.7699	1.7856	1.7812	1.7750	1.7714	1.7733
QG	1.6956	1.7097	1.7009	1.7005	1.6973	1.6989

# Generalized Cost Summary Table (gfuc)

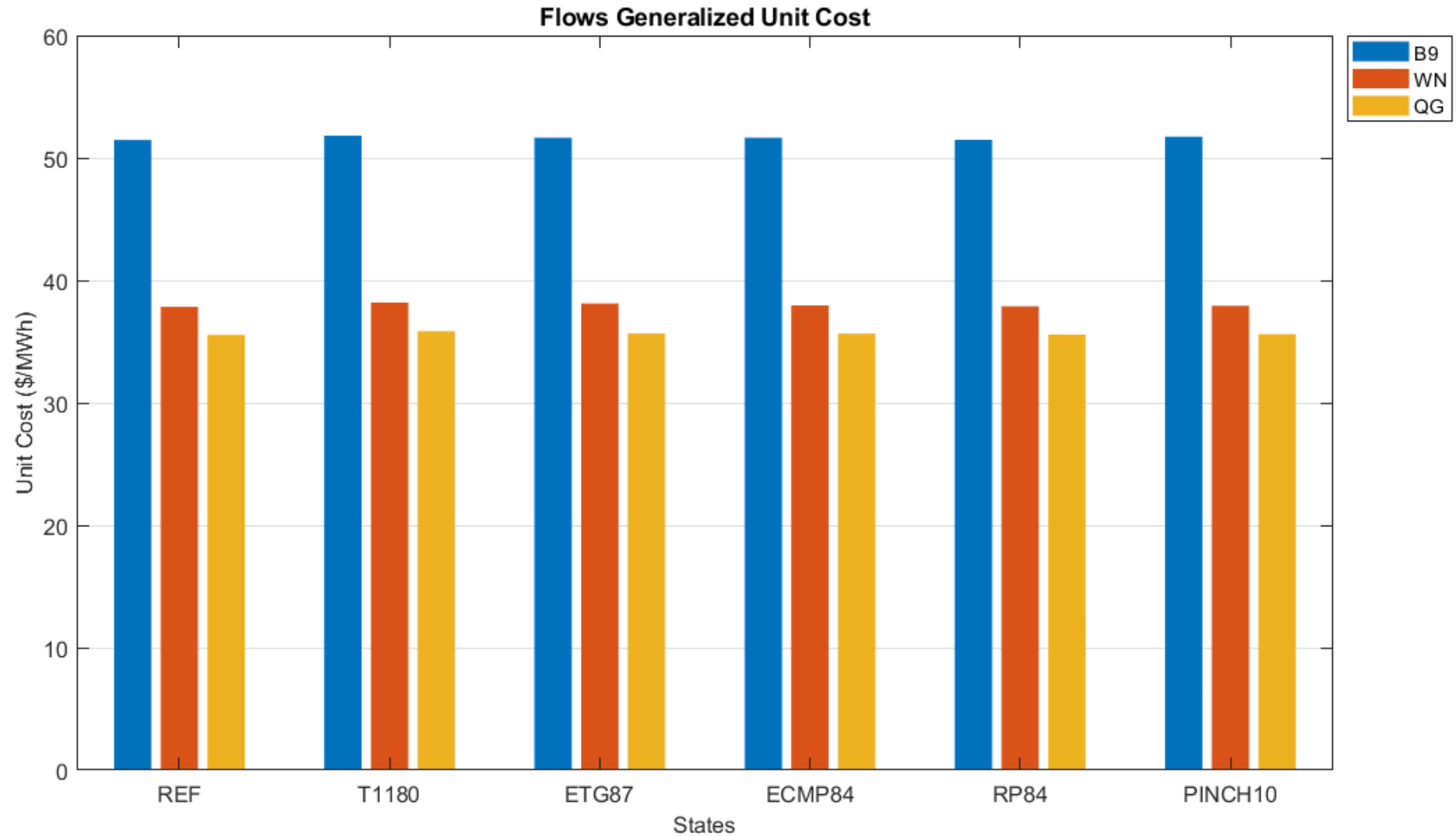

**Thanks for Your Attention**



**Universidad**  
Zaragoza